

TECHNICAL REPORTS

Understanding, Assessing, and Resolving Light-Pollution Problems on Sea Turtle Nesting Beaches

Blair E. Witherington and R. Erik Martin

Florida Department of
Environmental Protection



Lawton Chiles
Governor of Florida

Florida Department of Environmental Protection

Virginia B. Wetherell
Secretary



The Florida Marine Research Institute (FMRI) is a bureau of the Florida Department of Environmental Protection (FDEP). The FDEP's mission is to "protect, conserve, and manage Florida's environment and natural resources." The FMRI conducts applied research pertinent to managing marine-fishery resources and marine species of special concern in Florida.

Programs at the FMRI focus on resource-management topics such as managing gamefish and shellfish populations, restoring depleted fish stocks and the habitats that support them, protecting coral reefs, preventing and mitigating oil-spill damage, protecting endangered and threatened species, and managing coastal-resource information.

The FMRI publishes three series: *Memoirs of the Hourglass Cruises*, *Florida Marine Research Publications*, and *FMRI Technical Reports*. *FMRI Technical Reports* contain information relevant to immediate resource-management needs.

Kenneth D. Haddad, *Chief of Research*

James F. Quinn, Jr., *Science Editor*

Institute Editors

Theresa M. Bert, David K. Camp, Paul R. Carlson, Mark M. Leiby,
William G. Lyons, Anne B. Meylan, Robert G. Muller,
Ruth O. Reese, Carmelo R. Tomas

Judith G. Leiby, *Copy Editor*

Llyn C. French and James F. Quinn, Jr., *Publications Production*

Understanding, Assessing, and Resolving Light-Pollution Problems on Sea Turtle Nesting Beaches

Blair E. Witherington

Florida Department of Environmental Protection
Florida Marine Research Institute
19100 SE Federal Highway
Tequesta, Florida

and

R. Erik Martin

Ecological Associates, Inc
P. O. Box 405
Jensen Beach, Florida

**Florida Department of Environmental Protection
FMRI Technical Report TR-2**

1996

Cover Photograph

Tracks of disoriented loggerhead (*Caretta caretta*) hatchlings,
Melbourne Beach, Florida. Photograph by Blair E. Witherington.

Copies of this document may be obtained from

Florida Marine Research Institute
100 Eighth Ave. SE
St. Petersburg, FL 33701-5095
Attn: Librarian

Document Citation

Witherington, B. E., and R. E. Martin. 1996. Understanding, assessing, and resolving light-pollution problems on sea turtle nesting beaches. Florida Marine Research Institute Technical Report TR-2. 73 p.

Document Production

This document was designed in WordPerfect (v. 5.1) and Microsoft Word (v. 6.0) and formatted using Quark XPress[®] (v. 3.3) on Apple Power Macintosh[®] computers. Figures were created in Harvard Graphics[®] and exported to Adobe Illustrator[®] (v. 6.0). The headline font is Adobe[®] Avant Garde, the text font is Adobe[®] Palatino, and the cover headline is Adobe[®] Gill Sans. The cover and text papers are Consolidated Fortune Matte Recycled. Llyn C. French and James F. Quinn, Jr., of Florida Marine Research Institute, performed formatting, layout, graphics scans, and production for final film. Extra! Extra! Graphics Commercial Printers, St. Petersburg, Florida, printed the document, and it was finished by Associates Trade Bindery Inc., St. Petersburg.

Hatchling art, page vii: © 1987 by Flying Turtle Productions.



The cover and text papers used in this publication meet the minimum requirements of the American National Standard for Permanence of Paper for Printed Library Materials Z39.48—1992.

Table of Contents

ACKNOWLEDGMENTS	iv
EXECUTIVE SUMMARY	v
INTRODUCTION	1
PROBLEMS: THE EFFECTS OF ARTIFICIAL LIGHTING ON SEA TURTLES	2
<i>Sea Turtle Nesting</i>	2
The Nesting Process	2
Disruption of Nest-Site Selection	2
Nesting Behavior Abandonment and Abbreviation	4
Disruption of Sea-Finding	4
Low-Pressure Sodium-Vapor (LPS) Luminaires	5
<i>Hatchling Sea Turtle Orientation</i>	5
The Act of Sea-Finding	5
How Hatchlings Recognize the Ocean	6
Brightness Cues	6
Turning Toward Brightness	6
A Model for Measuring Brightness	7
Spectral properties of the brightness detector	7
Directional properties of the brightness detector	8
Color Cues	9
Shape Cues	11
Other Light Cues	12
When Cues Conflict	12
Disruption of Sea-Finding	12
Observations of Sea-Finding Disruption	12
Misorientation and Disorientation	13
Differences Between Natural and Artificial Lighting	14
Effects of Moon Phase and Moonlight	15
Swimming Orientation	15
ASSESSMENTS: DISCERNING PROBLEMS CAUSED BY ARTIFICIAL LIGHTING	16
<i>Lighting Inspections</i>	16
What Are Lighting Inspections?	16
Which Lights Cause Problems?	16
How Should Lighting Inspections Be Conducted?	16

Gather Background Information	16
Preliminary Daytime Inspections	16
Nighttime Inspections	17
When Should Lighting Inspections Be Conducted?	17
Who Should Conduct Lighting Inspections?	17
What Should Be Done with Information from Lighting Inspections?	17
<i>Monitoring Sea Turtle Behavior</i>	18
Sea Turtle Nesting	18
Hatchling Orientation	18
Hatchling-Orientation Surveys	18
Hatchling Disorientation Reports	18
SOLUTIONS: SOLVING PROBLEMS CAUSED BY ARTIFICIAL LIGHTING	20
<i>Light as a Pollutant</i>	20
Using Best Available Technology	20
<i>Effective Methods for Managing Light</i>	20
Turn Off Problem Lights	20
Minimize Beach Lighting from Outdoor Sources	21
Minimize Beach Lighting from Indoor Sources	21
Use Alternative, Long-Wavelength Light Sources	23
Low-Pressure Sodium Vapor	23
Yellow Filters, Bug Lights, and Red LEDs	23
How to Choose an Alternative Light Source	23
Use Light Screens and Enhance Dune Profile	24
A Comprehensive Strategy for Minimizing Effects of Artificial Lighting	24
Lighting Ordinances: How an Idea Becomes a Law	25
1. Become Familiar with the Issues	25
2. Develop a Summary Document of Relevant Local Issues	25
3. Develop a Presentation	25
4. Write a Preliminary Draft of the Legislation	25
5. Solicit Support for Legislation	26
6. Educate Governmental Staff	26
7. Educate Elected Officials	26
8. Make a Formal Recommendation to Adopt the Legislation	26
9. After the Legislation Is Adopted	27
Get the Word Out	27
Stay Involved	27

LITERATURE CITED28

APPENDIX A. Rating light sources by their effects on sea turtles37

APPENDIX B. Lamp types and their efficiency39

APPENDIX C. Incandescent lamps that least affect sea turtles40

APPENDIX D. Fixture styles for lighting that least affects sea turtles41

APPENDIX E. Diagrams of commonly available luminaires49

APPENDIX F. Solutions to common lighting problems56

APPENDIX G. Distributors of lighting products58

APPENDIX H. A model lighting ordinance for marine turtle protection60

APPENDIX I. Conservation organizations65

APPENDIX J. Responses to common questions67

APPENDIX K. A glossary of terms71

Acknowledgments

This work was funded by Florida's Marine Turtle Protection Trust Fund and by grants from the U.S. Fish and Wildlife Service and the Florida Game and Fresh Water Fish Commission. Partial funding of publication costs was contributed by an anonymous benefactor. We offer special thanks to Anne Meylan, Barbara Schroeder, and Mike Sole for their review of the manuscript and to Alan Huff and David Arnold for their assistance with the publication process. We gratefully acknowledge the information provided by the companies listed in Appendix G. In the text and appendices, we list lighting products that are acceptable for use near sea turtle nesting beaches. This listing of products and the companies that offer them is not exhaustive and is not meant to be complete.

Understanding, Assessing, and Resolving Light-Pollution Problems on Sea Turtle Nesting Beaches

Executive Summary

Sea turtle populations have suffered worldwide declines, and their recovery largely depends upon our managing the effects of expanding human populations. One of these effects is light pollution—the presence of detrimental artificial light in the environment. Of the many ecological disturbances caused by human beings, light pollution may be among the most manageable. Light pollution on nesting beaches is detrimental to sea turtles because it alters critical nocturnal behaviors, namely, how sea turtles choose nesting sites, how they return to the sea after nesting, and how hatchlings find the sea after emerging from their nests.

Both circumstantial observations and experimental evidence show that artificial lighting on beaches tends to deter sea turtles from emerging from the sea to nest. Because of this, effects from artificial lighting are not likely to be revealed by a ratio of nests to false crawls (tracks showing abandoned nesting attempts on the beach).

Although there is a tendency for turtles to prefer dark beaches, many do nest on lighted shores, but in doing so, the lives of their hatchlings are jeopardized. This threat comes from the way that artificial lighting disrupts a critical nocturnal behavior of hatchlings—crawling from their nest to the sea. On naturally lighted beaches, hatchlings escaping from nests show an immediate and well-directed orientation toward the water. This robust sea-finding behavior is innate and is guided by light cues that include brightness, shape, and in some species, color. On artificially lighted beaches, hatchlings become misdirected by light sources, leaving them unable to find the water and likely to incur high mortality from dehydration and predators. Hatchlings become misdirected because of their tendency to move in the brightest direction, especially when the brightness of one direction is overwhelmingly greater than the brightness of other directions, conditions that are commonly created by artificial light sources. Artificial lighting on beaches is strongly attractive to hatchlings and can cause hatchlings to move in the

wrong direction (misorientation) as well as interfere with their ability to orient in a constant direction (disorientation).

Understanding how sea turtles interpret light cues to choose nesting sites and to locate the sea in a variably lighted world has helped conservationists develop ways to identify and minimize problems caused by light pollution. Part of this understanding is of the complexity of lighting conditions on nesting beaches and of the difficulty of measuring light pollution with instrumentation. Thankfully, accurately quantifying light pollution is not necessary to diagnose a potential problem. We offer this simple rule: if light from an artificial source is visible to a person standing anywhere on a beach, then that light is likely to cause problems for the sea turtles that nest there.

Because there is no single, measurable level of artificial brightness on nesting beaches that is acceptable for sea turtle conservation, the most effective conservation strategy is simply to use “best available technology” (BAT: a common strategy for reducing other forms of pollution by using the best of the pollution-reduction technologies available) to reduce effects from lighting as much as practicable. Best available technology includes many light-management options that have been used by lighting engineers for decades and others that are unique to protecting sea turtles. To protect sea turtles, light sources can simply be turned off or they can be minimized in number and wattage, repositioned behind structures, shielded, redirected, lowered, or recessed so that their light does not reach the beach. To ensure that lights are on only when needed, timers and motion-detector switches can be installed. Interior lighting can be reduced by moving lamps away from windows, drawing blinds after dark, and tinting windows. To protect sea turtles, artificial lighting need not be prohibited if it can be properly managed. Light is properly managed if it cannot be seen from the beach.

Best available technology also includes light

sources that emit a color of light that has minimal effects on sea turtles. Light sources emitting low levels of short-wavelength light—sources that appear deep red or yellow—affect both hatchlings and nesting adults less than do sources emitting higher levels of short-wavelength light—sources that appear whitish or any color other than deep red or yellow. Low-pressure sodium-vapor luminaires are pure yellow sources that make good substitutes for more disruptive lighting near sea turtle nesting beaches. Yellow-tinted incandescent “bug-light” bulbs are not as pure a yellow source but can be an acceptable substitute.

Making the public aware of light-pollution problems on sea turtle nesting beaches is a fundamental step towards darkening beaches for sea turtles. Many of those responsible for errant lighting are unaware of its detrimental effects and are generally willing to correct the problem voluntarily once they become

aware. Nonetheless, legislation requiring light management is often needed, and on many nesting beaches, it may be the only means to completely resolve light-pollution problems. An outline for initiating, promoting, and implementing beach-lighting legislation is presented in this manual along with a model ordinance that can be used to help produce legislative drafts.

Appendices in the manual detail the appropriateness of lamp types, lamp colors, fixture designs, and fixture mounting for various lighting applications near sea turtle nesting beaches; give information for contacting lighting companies that offer appropriate lighting and for contacting governmental and nongovernmental organizations that can help with sea turtle conservation efforts; and present a list of responses to commonly encountered questions and comments regarding sea turtles and artificial lighting.

TRUST

*The sea produced an ancient form
with aquatic wings for soaring
that gouged the sand away from tide
above the ocean's pouring.*

*She abandoned hope to trust the past,
heaved forth the future and at last,
buried it and left.*

*Now, two moons hence, little turtles pip,
with soft struggling bodies hatching.
The sands ensconce as eggs are ripped
by contorted masses scratching.*

*The siblings toil at a common chore
to whittle ceiling into floor,
until at sand's surface just short of sky,
the unsettled lie, becalmed.*

*The tangled turtles wait
as heat of day abates
and cool of night prods
their reluctance away.*

*At dusk the fits and starts begin
and then through claw and strain,
above their heads sand rains again,
and yields to sky of night.*

*This army boiling in the night gains might,
and in waves, pours forth to see the sight.
Soft flippers patter and wipe sand from view
that eyes might seize upon the cue that betrays the sea.*

*And then, eyes do, they catch the glow
and every hatchling keen
rushes on to the goal they know
but they have never seen.*

*As if clockwork toys tightly wound
they keep pace and bearing tight,
for unless the sea is quickly found,
they will not survive the night.*

*They choose their erring paths
with neither doubt nor anticipation,
and their consistency deals them life or death
with quiet resignation.*

*Thus, night wanes and sights of light remaining
scatter throngs persistent
and about the dune abundant obstacles restraining,
divide the dying from the spent.*

*Weakened few reach the sight they sought,
a deceptive brightness reassuring
where trusting forms are caught
by the sight of lights alluring.*

*Dawn now dries their searching eyes
and death now rests the weary.
Might fate have been more kind
to travelers more leery?*

*Were these turtles to awaken,
could they sense their mother's plight
having left her young forsaken
owing confidence in light?*

*Past's light offered not such bitter seas
nor played such deadly roles
to guide hatchlings on to sights like these
electric lights on poles.*

*Might we masters of the light adapt,
forgo complete control,
and lessen obsolescence
lest our presence take its toll?*

*To tread on earth with darkness soft
leaves not the night asunder
and preserves the stars and moon aloft,
and obsoleted wonders.*

—BEW

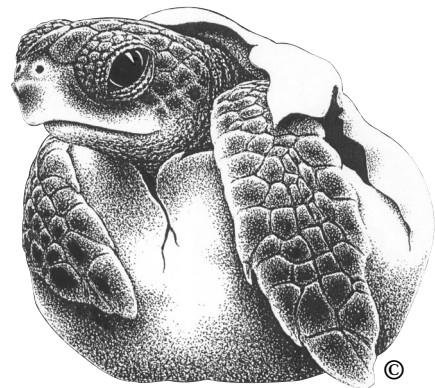

Understanding, Assessing, and Resolving Light-Pollution Problems on Sea Turtle Nesting Beaches

Introduction

In the sliver of time since Europeans began migrating throughout the tropical oceans of the world, sea turtle populations have declined and many have been extirpated. As a group, sea turtles are considered dangerously close to extinction. Because of their precarious status, sea turtles have been afforded protection by local, state, provincial, and national laws and by international treaties. In the United States and its territories, the Endangered Species Act of 1973 prohibits all killing, harming, and harassment of six species of sea turtles: the green turtle (*Chelonia mydas*), the loggerhead (*Caretta caretta*), the hawksbill (*Eretmochelys imbricata*), Kemp's ridley (*Lepidochelys kempi*), the olive ridley (*Lepidochelys olivacea*), and the leatherback (*Dermochelys coriacea*).

It is perhaps on ocean beaches where the activities of people and sea turtles are most conspicuously intertwined. On these narrow strips of sand, people live, recreate, and conduct commerce—and sea turtles come to reproduce. Although sea turtles spend very little of their lives on beaches, their activities there are critical to the creation of the next generation. Sea turtles leave little more disturbance on the beach than a mound of sand and are likely to make no more of an impression on human inhabitants than to awaken a sense of wonder. Humans, however, can cause profound environmental changes in the places they visit. The consequences of such changes for sea turtles can be severe and are of great concern to those working for sea turtle conservation. An integral goal of sea turtle conservation efforts is to reduce deleterious human effects such as habitat alteration. In this manual, we will examine a distinctive and particularly damaging type of habitat alteration that affects sea turtles at the nesting beach, namely, light

pollution—the introduction of artificially produced detrimental light into the environment.

Light from artificial sources differs markedly from other pollutants both in its form—light is energy rather than substance—and in its effect on sea turtles. Whereas heavy metal, petroleum, and other chemical pollutants produce predominately physical or physiological effects, the effect that light pollution has on sea turtles is essentially psychological. For sea turtles, artificial light is best described not as a toxic material but as misinformation. With its great potential to disrupt behaviors that rely on correct information, artificial lighting can have profound effects on sea turtle survival. Critical sea turtle behaviors affected by light pollution include the selection of nesting sites by adult turtles and the movement off the beach by hatchlings and adults.

Raymond (1984a) presented the first summary of the effects of light pollution on hatchling sea turtles and some potential solutions to this problem. The present manual can be considered an expanded update of the material presented by Raymond. Our goals here are to offer new perspectives on the problem of light pollution at sea turtle nesting beaches and to present recently acquired information both on the problem itself and on the strategies and mechanics by which the problem can be solved. Our presentation is geared for biologists, conservationists, and managers who may be consulted about or charged with solving problems caused by artificial lighting on sea turtle nesting beaches. However, this manual is also meant to inform the lay person who may work or live near a nesting beach and is concerned about sea turtle conservation.

Problems: The Effects of Artificial Lighting on Sea Turtles

Sea Turtle Nesting

THE NESTING PROCESS

Sea turtles are marine reptiles that deposit their eggs above the high-tide line on sand beaches. Sea turtle nesting is seasonal and for most populations begins in late spring and concludes in late summer. Although more than one sea turtle species may nest on the same beach, their nesting seasons are often slightly offset. In Florida (USA), for instance, leatherbacks begin nesting in mid-March and conclude in mid-July, loggerheads begin nesting in early May and conclude in late August, and green turtles begin nesting in early June and conclude by mid-September (Meylan *et al.*, 1995).

Except for the flatback turtle (*Natator depressus*; B. Prince, personal communication), Kemp's ridley (Pritchard and Marquez, 1973), and some populations of hawksbills (Brooke and Garnett, 1983), sea turtle nesting occurs almost exclusively at night. All sea turtle species have in common a series of stereotyped nesting behaviors (descriptions given by Carr and Ogren, 1959; Carr *et al.*, 1966; Bustard, 1972; Ehrenfeld, 1979; Hirth and Samson, 1987; Hailman and Elowson, 1992; Hays and Speakman, 1993), although there are subtle differences between species and some elements of this behavior may vary between individuals and between nesting attempts. For example, nesting behavior may vary in where turtles emerge onto land, in where on the beach they begin to construct their nests, in whether they abandon their nesting attempts and at what nesting stage they abandon the attempts, and in the directness of their paths as they return to the sea. These variations in nesting behavior can affect the success of egg deposition and hatchling production and can affect the well-being of the nesting turtle.

During the process of nesting, an adult female sea turtle 1) emerges from the surf zone, 2) crawls up the beach to a point typically between the high-tide line and the primary dune, 3) prepares the nest site by pushing or digging surface sand away to form a "body pit," 4) digs an "egg cavity" within the body pit using the rear flippers, 5) deposits eggs within the egg cavity, 6) covers the eggs with sand, 7) camouflages the nest site by casting sand, principally with front-flipper strokes, 8) turns toward the sea, and 9) crawls into the surf (Hailman and Elowson, 1992,

include an additional "wandering" phase). For the most part, the pattern of each of these behaviors (how they are performed) is not affected as greatly by external stimuli (such as the presence of humans or lights) as are the "decisions" that determine the timing, duration, and accuracy of these behaviors. Functionally, these decisions affect the selection of a nest site, the abandonment or abbreviation of nesting behaviors, and the accuracy of sea-finding.

DISRUPTION OF NEST-SITE SELECTION

Sea turtles select a nest site by deciding where to emerge from the surf and where on the beach to put their eggs. The most clearly demonstrated effect of artificial lighting on nesting is to deter turtles from emerging from the water. Evidence for this has been given by Raymond (1984b), who reported on a dramatic reduction in nesting attempts by loggerheads at a brightly lighted beach site in Florida. Elsewhere in Florida, Mattison *et al.* (1993) showed that there were reductions in loggerhead nesting emergences where lighted piers and roadways were close to beaches. Mortimer (1982) described nesting green turtles at Ascension Island as shunning artificially lighted beaches. Additional authors have noted a relationship between lighted beach development and reduced sea turtle nesting: Worth and Smith (1976), Williams-Walls *et al.* (1983), Proffitt *et al.* (1986), and Martin *et al.* (1989) for loggerheads in Florida; Witherington (1986), Worth and Smith (1976), and Ehrhart (1979) for green turtles in Florida; and Dodd (1988), Witham (1982), and Coston-Clements and Hoss (1983) in reviews of human impacts on sea turtle nesting. Salmon *et al.* (1995a) found that loggerheads that do nest on beaches where the glow of urban lighting is visible behind the dune tend to prefer the darker areas where buildings are silhouetted against the artificial glow. Other authors have mentioned reduced nesting activity at lighted and developed beaches (Talbert *et al.*, 1980) or nesting in spite of lighted development (Mann, 1977) but have reserved judgment on the effects of lighting because of other contributing factors such as increased human activity near developed areas.

In addition to evidence pointing to a correlation between lighted beaches and reduced nesting, there is evidence from experimental field work that directly implicates artificial lighting in deterring sea turtles

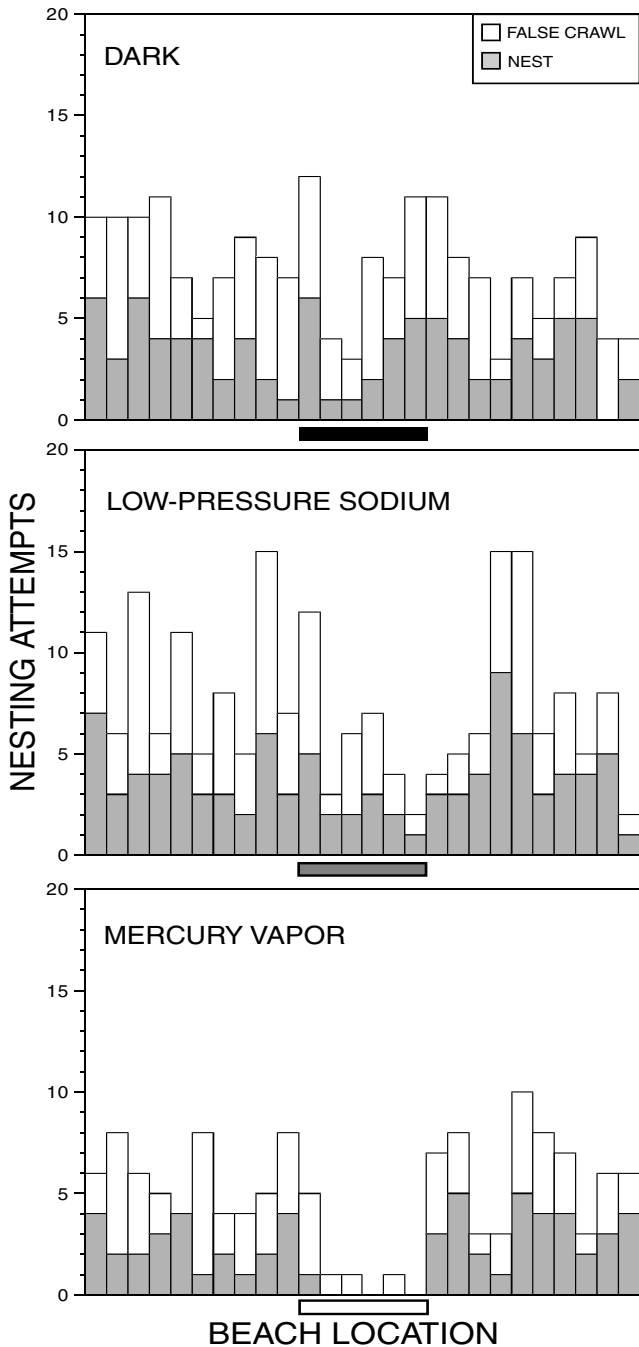

Figure 1. The distribution of loggerhead nesting attempts on a 1,300-m stretch of beach at Melbourne Beach, Florida. The beach locations were divided into 50-m sections. The horizontal bars show the section of beach where luminaires were set up—either lighted mercury-vapor luminaires (open bar), lighted low-pressure sodium-vapor luminaires (shaded bar), or luminaires that were not lighted (dark bars). Data are from Witherington (1992a).

from nesting (Witherington, 1992a). In these experiments, undeveloped nesting beaches were left dark or were lighted with one of two types of commercial

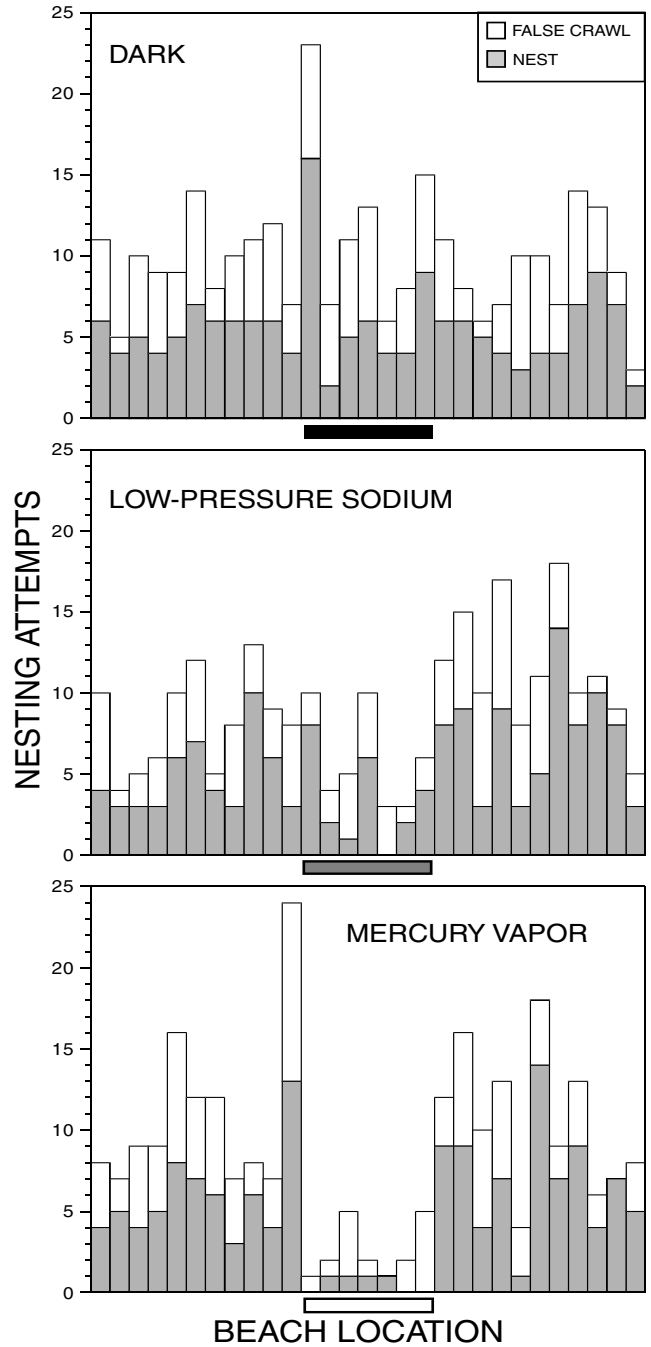

Figure 2. The distribution of green turtle nesting attempts on a 1,450-m stretch of beach at Tortuguero, Costa Rica. Identifications are as in Figure 1.

light sources. Both green turtles and loggerheads showed a significant tendency to avoid stretches of beach lighted with white mercury-vapor luminaires (Figures 1 and 2). However, any effect of yellow low-pressure sodium-vapor luminaires on loggerhead or green turtle nesting could not be detected. Because the mercury-vapor lighting reduced both nesting

and nonnesting emergences, it seems that the principal effect of artificial lighting on nesting is to deter turtles from exiting the water. This means that one cannot rely on a ratio of nesting and nonnesting tracks to reveal effects from artificial lighting. The reason why artificial lighting deters nesting emergences is not known. It may be that artificial lighting on a beach is perceived by the turtles as daylight, which may suppress behavior that is usually nocturnal.

Once on the beach, sea turtles select a place to make a nest. In the field experiments by Witherington (1992a), artificial lighting had no effect on how far from the dune sea turtles placed their nests. Nest placement on the beach may depend most heavily on nonvisual cues such as temperature gradients (Stoneburner and Richardson, 1981).

The artificial lighting of sea turtle nesting beaches can be considered a form of habitat loss. When lighting deters sea turtles from nesting beaches, nesting turtles may be forced to select less appropriate nesting sites. Worth and Smith (1976) reported that loggerheads deterred from nesting re-emerged onto beaches outside their typical range. Murphy (1985) found that loggerheads that were repeatedly turned away as they made nesting attempts chose increasingly distant and inappropriate nesting sites in subsequent nesting attempts. If we assume that sea turtles choose nesting sites based upon favorable conditions for safe nesting and the production of fit offspring, then light pollution can be said to force some turtles into suboptimal nesting habitat. At suboptimal nesting beaches, the number of hatchlings produced and their survivorship may be compromised, and hatchling sex ratios may be affected. There is also the potential that turtles deterred from nesting may shed their eggs at sea. In the Caribbean, adult female turtles held in pens during the nesting season often drop their eggs without nesting (A. Meylan, personal communication).

NESTING BEHAVIOR ABANDONMENT AND ABBREVIATION

Sea turtles that emerge onto beaches often abandon their nesting attempts before putting their clutches of eggs into the sand. Nesting success (the number of nests divided by attempts) varies between beaches and between species. Among 28 Florida nesting beaches surveyed in 1994, nesting success for loggerheads was 53% ($n = 52,275$ nests), 52% for green turtles ($n = 2,804$ nests), and 83% for leatherbacks ($n = 81$ nests) (Florida Department of Environmental Protection, Index Nesting Beach Survey Program). Nesting success for Florida loggerheads in 1994 was 61% ($n =$

3,704 nests) at the undeveloped beaches of the Canaveral National Seashore and 45% ($n = 6,026$ nests) at the residential and heavily armored beaches of Jupiter Island. Sea turtles will abandon nesting attempts when they encounter digging impediments, large structures, unsatisfactory thermal cues, or human disturbance; when there are injuries to the rear flippers; or when other influences recognized thus far only by the turtles deter them (BEW and REM, unpublished data; Stoneburner and Richardson, 1981; Fangman and Rittmaster, 1993).

Sea turtles are most prone to human disturbance during the initial phases of nesting (emergence from the sea through egg-cavity excavation; Hirth and Samson, 1987), and during this period, green turtles are reported to be deterred by people with flashlights (Carr and Giovannoli, 1957; Carr and Ogren, 1960). Our experiences with nesting loggerheads and green turtles have been that the presence of people moving within the field of view of a turtle may cause abandonment just as often as—and perhaps more often than—hand-held lighting, but this has yet to be studied experimentally.

In one study (Witherington, 1992a), stationary lighting could not be shown to cause loggerheads and green turtles to abandon their nesting attempts on the beach. In that study, however, so few turtles emerged onto the mercury-vapor-lighted portion of the beach that recorded nesting attempts were insufficient for a proper test of nesting success.

Although sea turtles are less prone to abandon nesting attempts once oviposition has begun, the normal post-oviposition behavior of covering the eggs and camouflaging the nest site can be abbreviated if a turtle is disturbed. Johnson *et al.* (1996) measured the behavior of loggerhead turtles observed by turtle-watch ecotourism groups and found that the “watched” nesting turtles had shorter-than-average bouts of nest covering and camouflaging. We have made similar observations of turtles “watched” by unorganized groups of people with flashlights. In one instance, BEW observed that a green turtle illuminated by a bright flashlight covered its eggs, cast sand, and began a return to the sea in less than five minutes following oviposition (green turtles normally take approximately 50 minutes for these behaviors; Hirth and Samson, 1987). We know of no studies that attribute an abbreviation of nesting behavior to the effects of stationary lighting near nesting beaches.

DISRUPTION OF SEA-FINDING

After a sea turtle has camouflaged her nest, she must orient toward the sea and return there. Experiments with blindfolded green turtles that had finished nest-

ing (Ehrenfeld and Carr, 1967; Ehrenfeld, 1968), experiments with blindfolded immature green turtles (Caldwell and Caldwell, 1962), and observations of orientation in nesting leatherbacks (Mrosovsky and Shettleworth, 1975) all indicate that these turtles rely on vision to find the sea. The blindfolding experiments allowed Ehrenfeld (1968) to determine how the light reaching each eye of an adult turtle influenced the direction it would turn and which way it would travel relative to the sea. The mechanism for this phototropotaxis—literally, turning and movement with respect to light—seemed to match the way that other, much simpler, organisms orient toward light. In essence, the turtles appeared to turn so that perceived light intensity was balanced between their eyes, a balance that seemed to guarantee orientation in the brightest direction.

Given an adult turtle's reliance on brightness for correct seaward orientation, it is not surprising that this sea-finding behavior is disrupted by artificial lighting. However, it is surprising how rarely this occurs. Turtles attempting to return to the sea after nesting are not misdirected nearly as often as are hatchlings emerging on the same beaches. In the lighted-beach experiments described by Witherington (1992a), few nesting turtles returning to the sea were misdirected by lighting; however, those that were (four green turtles and one loggerhead) apparently spent a large portion of the night wandering in search of the ocean.

Because misdirected nesting turtles may not be able to re-enter the ocean because of topography and obstacles, disruption of sea-finding may mean much more to nesting turtles than simple delay. At Jumby Bay, Antigua, a hawksbill that had nested was found far from the beach and crawling toward distant security lighting (C. Ryder, personal communication). At Hutchinson Island, Florida, adult loggerheads have left the beach and been found crawling toward parking-lot lighting near a busy highway or floundering in shallow ponds near condominium lighting (REM, personal observation). At Melbourne Beach, Florida, a green turtle wandered off the beach in the direction of mercury-vapor lighting and was found in a roadside parking lot (BEW, personal observation). Observers believed that none of these turtles would have been able to return to the sea without assistance. At Patrick Air Force Base, Florida, assistance came too late for a nesting loggerhead that had wandered toward a high-pressure sodium-vapor floodlight and onto a nearby highway, where it was struck and killed by a passing car (S. Johnson, personal communication).

LOW-PRESSURE SODIUM-VAPOR (LPS) LUMINAIRES

Low-pressure sodium-vapor (LPS) lighting emits a pure (single-wavelength or monochromatic) yellow light that seems to affect nesting turtles less than light from other sources, at least in loggerheads and green turtles (Witherington, 1992a). Light from LPS sources may appear dim or as an innocuous color to nesting sea turtles. If light levels do in fact determine the timing of nesting, then the yellow light from LPS may not provide the same stimulus that daylight does in deterring nesting behavior.

Although no direct effect of LPS lighting on nesting is apparent, indirect effects cannot be ruled out. For instance, even if LPS lighting were ignored by turtles, its light could indirectly increase human activity on the beach, which could interfere with nesting. Turtles nesting in lighted areas may be more conspicuous and therefore may be more likely to be approached by people visiting the beach. This lighting, in turn, may make people more conspicuous to turtles. People moving on the beach within sight of a loggerhead or green turtle that has not yet deposited her eggs will cause her to abandon the nesting attempt in most instances (BEW, unpublished data).

Hatchling Sea Turtle Orientation

THE ACT OF SEA-FINDING

One of the most critical acts a sea turtle must perform takes place immediately after it views the world for the first time as a hatchling. Approximately one to seven days after hatching from eggs beneath the sand (Demmer, 1981; Christens, 1990), hatchlings emerge from their nest *en masse* and orient toward the sea without delay. This emergence of hatchlings and subsequent sea-finding takes place principally at night (Hendrickson, 1958; Carr and Hirth, 1961; Bustard, 1967; Neville *et al.*, 1988; Witherington *et al.*, 1990), although some early-morning (Chavez *et al.*, 1968) and late-afternoon (Witzell and Banner, 1980) emergences have been reported. Loggerhead hatchlings in Florida emerge between dusk and dawn, with a peak emergence time near midnight (Witherington *et al.*, 1990; Figure 3).

Under natural conditions, hatchling sea turtles that have just emerged from the sand crawl in a frenzy directly from nest to sea. The zeal characterizing this seaward crawl is justified given the consequences of delay—death. Hatchlings that are physically kept from the sea or that have their sea-finding disrupted by unnatural stimuli often die from exhaustion, dehydration, predation, and other causes

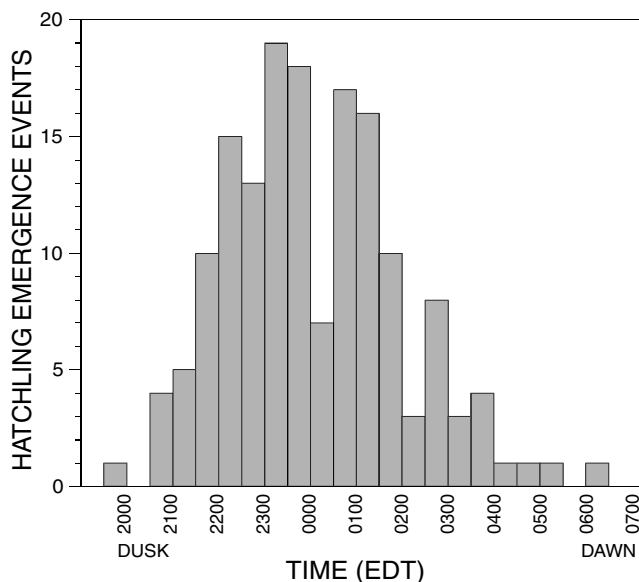

Figure 3. The timing of 157 loggerhead hatchling emergence events from natural nests at Melbourne Beach, Florida, between 29 July and 1 September 1988. An emergence event was defined as the movement of 10 or more hatchlings from nest to sea. Data are from Witherington et al. (1990).

(McFarlane, 1963; Philibosian, 1976; Hayes and Ireland, 1978; Mann, 1978).

HOW HATCHLINGS RECOGNIZE THE OCEAN

The first authors to study the sea-finding behavior of sea turtle hatchlings focused on associations between observed behavior and potential environmental cues (Hooker, 1907, 1908a, b) and later verified which of a hatchling's senses were necessary for sea-finding (Hooker, 1911; Parker, 1922; Daniel and Smith, 1947a, b; Carr and Ogren, 1960). A major conclusion of these early studies was that hatchlings rely almost exclusively on vision to recognize the sea. There are a number of supporting observations:

1. Hatchlings with both eyes blindfolded circle or remain inactive and seem to be unable to orient directly to the sea (Daniel and Smith, 1947a; Carr and Ogren, 1960; Mrosovsky and Shettleworth, 1968, 1974; Mrosovsky, 1977; Rhijn, 1979).
2. Visual stimuli such as light shields (Hooker, 1911; Parker, 1922; Carr and Ogren, 1959, 1960; Mrosovsky and Shettleworth, 1968, 1975) and artificial lighting (Daniel and Smith, 1947a; Hendrickson, 1958; McFarlane, 1963; Mann, 1978) greatly interfere with hatchling sea-finding performance.
3. Placing hatchlings where the ocean horizon cannot be seen but where other, nonvisual, cues should be detectable typically prevents seaward orientation

(Hooker, 1908b; Daniel and Smith, 1947a; Carr and Ogren, 1960; Carr *et al.*, 1966; Mrosovsky, 1970).

Although studies suggest that hatchlings may be able to respond to beach slope, nonvisual cues such as this appear to have a small influence on directional movement and probably do not come into play when light cues are available (Rhijn, 1979; Salmon *et al.*, 1992).

BRIGHTNESS CUES

A great deal of evidence suggests that brightness is an important cue used by hatchlings in search of the ocean. Hatchlings move toward bright artificial light sources in both laboratory and field settings (Daniel and Smith, 1947a; Hendrickson, 1958; Mrosovsky and Shettleworth, 1968) and toward reflective objects on the beach (Carr, 1962).

The role of brightness in sea-finding has two basic issues. The first issue is the mechanism by which hatchlings use their eyes and brain to point themselves in the brightest direction—how they turn toward brightness. The second issue is a model that describes the properties of brightness that are important to a hatchling—how we might predict where a hatchling will go.

TURNING TOWARD BRIGHTNESS

Two mechanisms have been proposed to explain how hatchling sea turtles turn toward the brightest direction. Evidence for the first mechanism comes from experiments that have capitalized on the odd turning or "circus movements" made by hatchlings that are partially blindfolded (Mrosovsky and Shettleworth, 1968). In this mechanism, hatchlings are described as having many light-intensity comparators within each eye that would give hatchlings a way to compare the light intensity reaching them from different directions. Thus, if the comparator aimed posteriorly within the left eye of a hatchling (a comparator that would be near the nasal margin of the curved retina of the left eye) detects the brightest input of light, the hatchling would "know" to turn left in order to orient in the brightest direction. Similarly, after turning toward the brightness until the light-intensity inputs between the eyes are balanced, the hatchling would "know" that it has reached an orientation in the brightest direction. This mechanism has been called a complex phototropotaxis system (Mrosovsky and Kingsmill, 1985)—complex refers to the many comparators involved and phototropotaxis (*photos* = light, *tropos* = a turning, *tasso* = to arrange) refers to a turning and movement toward light.

In a second mechanism that has been proposed,

hatchlings are described as having an integrated array or “raster system” of light sensors within both eyes that would allow a hatchling to instantaneously interpret the brightest direction. Rather than sensing detail, this hypothesized raster system would integrate a measure of brightness over a broad area. This mechanism is referred to as a telotaxis system (Verheijen and Wildschut, 1973; Mrosovsky and Shettleworth, 1974; Mrosovsky *et al.*, 1979)—telotaxis (*telopos* = seen from afar, *tasso* = to arrange) refers to a fixation on and movement toward a target stimulus.

Unfortunately, the differences in these proposed mechanisms are too subtle to allow them to be separated by the experimental evidence at hand. The more “complex” a phototropotaxis mechanism becomes, the more it functionally resembles a telotaxis mechanism (Schöne, 1984). The actual visual-neural system that hatchlings use to turn toward the brightest direction and maintain that orientation may incorporate aspects of each of the proposed mechanisms.

A MODEL FOR MEASURING BRIGHTNESS

To determine the brightest direction, hatchlings must be able to “measure” brightness. Knowing the properties of the “brightness detector” used in this measurement is essential to our understanding a hatchling’s response to its world. Although simplistic, modeling hatchlings as biological brightness-detectors is a useful way to introduce the properties of light that most affect hatchling orientation.

Spectral properties of the brightness detector.—The spectral properties of a detector—or an eye—reveal its sensitivity to different wavelengths of light. In bright light, we see different wavelengths and combinations of wavelengths as color. However, independent of color, some wavelengths appear brighter to us than others, just as there are some wavelengths we cannot see.

The term “brightness” is often used in the sea turtle orientation literature and generally refers to the intensity and wavelength(s) of light relative to the spectral sensitivity of an individual (Ehrenfeld and Carr, 1967; Mrosovsky, 1972; Rhijn, 1979; Mrosovsky and Kingsmill, 1985). Brightness is undoubtedly in the eye of the beholder. The different-colored photopigments and oil droplets within the retina of a sea turtle’s eye (Granda and Haden, 1970; Liebman and Granda, 1971; Granda and Dvorak, 1977) provide a unique set of conditions that influence how sea turtles make their determination of brightness.

Researchers have learned much about sea turtles’ perception of brightness by using a procedure

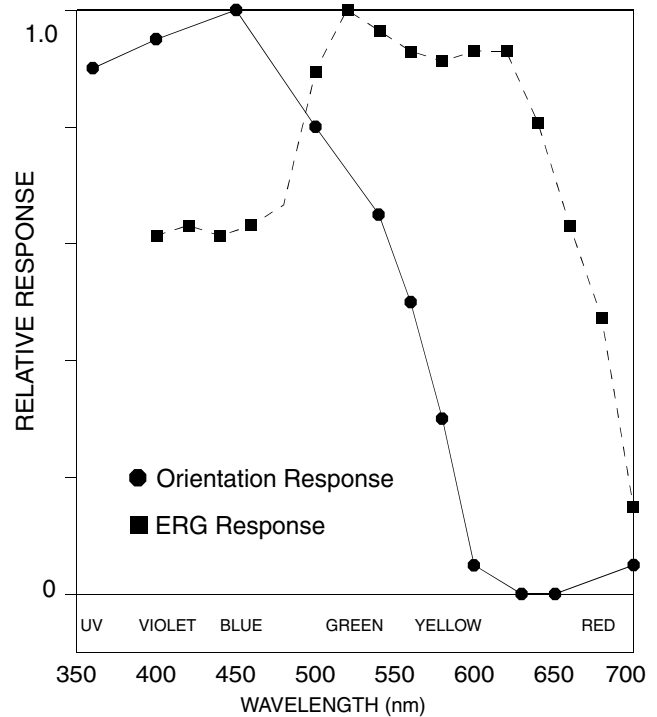

Figure 4. A comparison of the orientation and physiological (ERG) responses of green turtle hatchlings to colored light. The orientation response curve shows how attractive the light is to green turtle hatchlings, and the ERG response curve gives an approximation of how bright the light appears to them. Orientation data are from Witherington (1992b), and ERG data are adapted from Granda and O’Shea (1972). Figure adapted from Witherington (*in press*); used with permission.

called electroretinography (ERG) to measure the relative electrical potential across retinas of turtles exposed to different wavelengths of light. ERG data show that green turtles are most sensitive to light in the violet to orange region of the visible spectrum, from 400 to 640 nm (Figure 4; Granda and O’Shea, 1972). In daylight, green turtles show a greater spectral sensitivity within the shorter-wavelength (blue) region of the spectrum than humans do.

Although ERG data provide important physiological information, the most direct way to determine the effects of spectral light on orientation is to conduct behavioral experiments. The earliest studies on hatchlings’ responses to light wavelength employed broad-band (multiple-wavelength-transmission) filters to vary the wavelengths that reached orienting hatchlings (Mrosovsky and Carr, 1967; Mrosovsky and Shettleworth, 1968). Although reactions to specific wavelengths could not be determined, it was clear that the green turtle hatchlings studied were more attracted to blue light than to red light.

In later experiments, researchers used narrow-

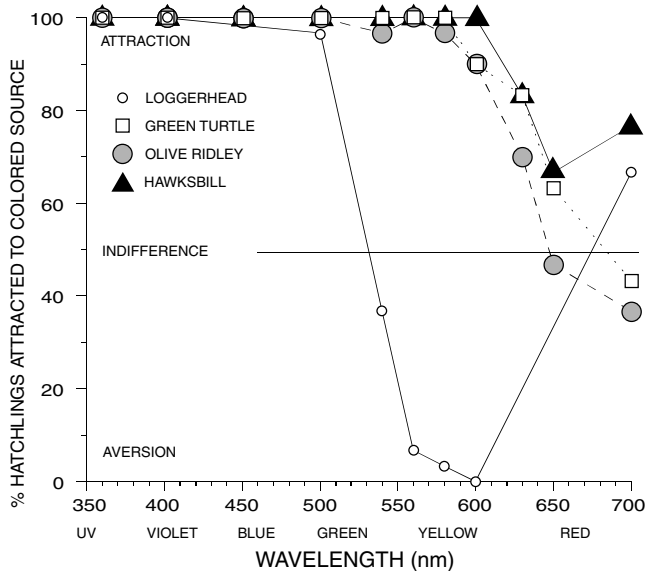

Figure 5. Orientation responses of four species of sea turtle hatchlings to colored light sources. Responses were measured as the proportion of hatchlings that chose a window lighted with a colored light source over a similar but darkened window (Witherington, 1992b). The loggerhead differed from the other species in that it showed an aversion to light in the yellow region of the spectrum. Figure adapted from Witherington (in press) and Lohmann et al. (in press); used with permission.

band (monochromatic) filters to vary the wavelengths reaching loggerhead, green turtle, hawksbill, and olive ridley hatchlings (Witherington and Bjornstad, 1991a; Witherington, 1992b). The use of monochromatic filters allowed a simple measure of light intensity so that researchers could determine the responses of hatchlings to a set number of photons at each of several wavelengths. As in previous experiments, hatchlings showed a preference for short-wavelength light. Green turtles, hawksbills, and olive ridleys were most strongly attracted to light in the near-ultraviolet to yellow region of the spectrum and were weakly attracted or indifferent to orange and red light (Figure 5). Loggerheads were most strongly attracted to light in the near-ultraviolet to green region and showed an unexpected response to light in the yellow region of the spectrum. At intensities of yellow light comparable to a full moon or a dawn sky, loggerhead hatchlings showed an aversion response to yellow light sources (Figure 5), but at low, nighttime intensities, loggerheads were weakly attracted to yellow light (Figure 6). It may be that the hatchlings cannot discriminate color at low light levels. This is common for animals (such as turtles) that have rod-and-cone retinas (Granda and Dvorak, 1977).

It should come as no surprise that humans and

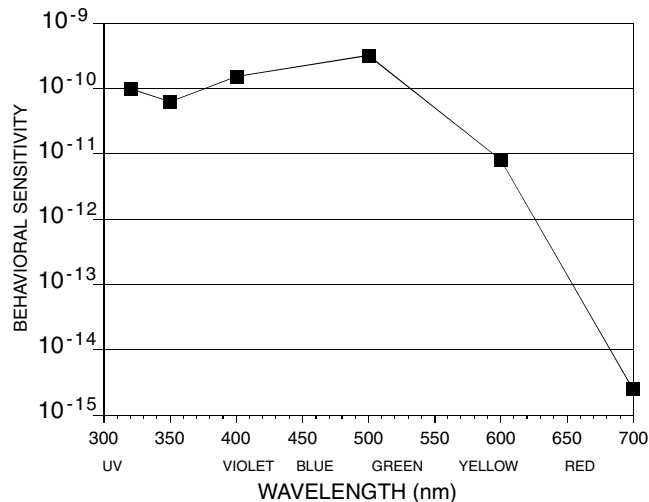

Figure 6. Behavioral sensitivity of loggerhead hatchlings to low-intensity colored light, represented as the inverse of the light-source radiance required to evoke significantly directed orientation in groups of hatchlings ($n = 30$ per wavelength). At the low light levels represented here (approximately the radiance of the sky on a full-moon night, and dimmer), there was orientation toward the light source at all wavelengths. The ordinate is a log scale of the units (photons/s/m²/sr)⁻¹. Data are from Witherington (1992b). Figure adapted from Witherington (in press) and Lohmann et al. (in press); used with permission.

sea turtle hatchlings see the world differently. For most of their lives, sea turtles see the world through a blue ocean filter (water selectively absorbs reddish, long-wavelength light), so it makes sense that sea turtles would be most sensitive to short-wavelength light.

Because sea turtle hatchlings respond to light that we cannot see (ultraviolet light) and are only weakly sensitive to light that we see well (red light), instruments that quantify light from a human perspective (such as most light meters) cannot accurately gauge brightness from the perspective of a sea turtle. Humans also cannot assess color exactly as a sea turtle would. Although we can see colors, we cannot tell what assortment of wavelengths may make up those colors. For example, a light source emitting both 525-nm (green) and 645-nm (red) light, a source highly attractive to hatchlings, appears to a human observer to emit yellow light comparable to a 588-nm monochromatic source, which would be only weakly attractive to hatchlings (Rossotti, 1983).

Directional properties of the brightness detector.—Just as a hatchling's detector has a sensitivity to specific light wavelengths, it is also sensitive to light direction. The directional properties of a detector determine how much of the world the detector measures

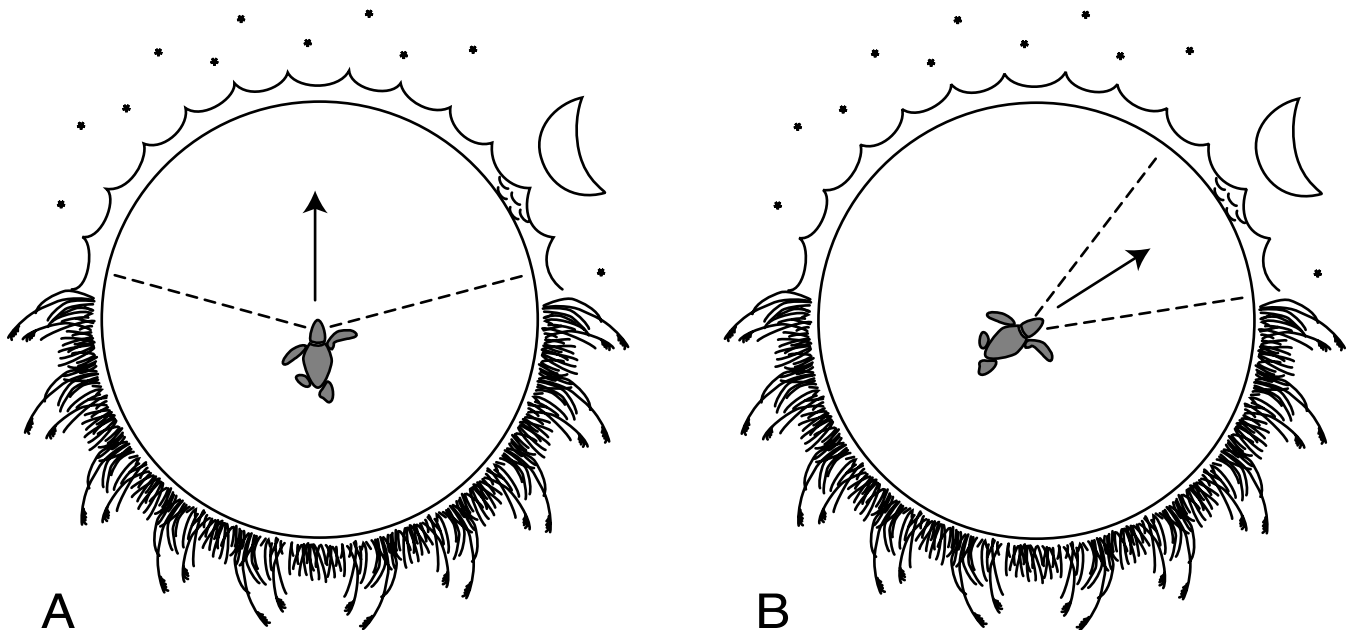

Figure 7. The consequences of measuring the brightest direction with a wide (A) or a narrow (B) angle of acceptance. Hatchlings A and B both orient toward the center of the brightest portion of the horizon within their angle of acceptance (shown by dotted lines). Hatchling B's path to the water would be considerably longer. Figure adapted from Witherington (in press); used with permission.

at any one instant. These properties are described by a specific "cone of acceptance" or by bidimensional (horizontal and vertical) "angles of acceptance." The height and breadth of a detector's acceptance cone critically influences brightness measurements and the determination of brightest direction (Figure 7). This conceptual acceptance cone may be only a portion of a turtle's complete field of view.

The horizontal component of the acceptance cone for green turtle and olive ridley hatchlings (Verheijen and Wildschut, 1973) and for loggerhead hatchlings (Witherington, 1992b) has been deduced from the way that hatchlings orient in controlled light fields. In these studies, light fields were artificially controlled so that detectors with different acceptance-cone widths measured different brightest directions. Hatchlings of each species typically oriented in the brightest direction as it would be measured with a wide acceptance cone, approximately 180° horizontally.

To determine the vertical component of the acceptance cone, the researchers cited above measured the orientation of hatchlings presented light sources that were positioned at various vertical angles. The angular height of this vertical component was approximated to be "a few degrees" for green turtles and olive ridleys (Verheijen and Wildschut, 1973) and between 10° below and 30° above the horizon for loggerheads (Salmon and Wyneken, 1990;

Witherington, 1992b). Although the measures are approximate, it is clear that light closest to the horizon plays the greatest role in determining orientation direction.

The detector model for hatchling orientation predicts that hatchlings measure brightest direction by integrating the light they detect over a broad and flat acceptance cone (Figure 8). Again, we see that the attributes of this hypothetical detector differ from those of most light meters. The most commonly found light meters, illuminance meters, measure light with an acceptance cone that is less flattened and not as wide as the acceptance cone that hatchlings use. Another type of light meter, a luminance or "spot" meter, measures light with a very narrow acceptance cone. Careful consideration should be given to the directional attributes of a light-measuring instrument if its measurements are to be used in predicting hatchling behavior.

COLOR CUES

In addition to brightness cues, color may also influence the direction that a hatchling orients. Color discrimination (the ability to identify colored light) is different from spectral sensitivity. An animal may be able to detect many light wavelengths that it cannot tell apart. The fact that sea turtles have cones in their retinas is not sufficient evidence that sea turtles see color; however, some behavioral evidence can be

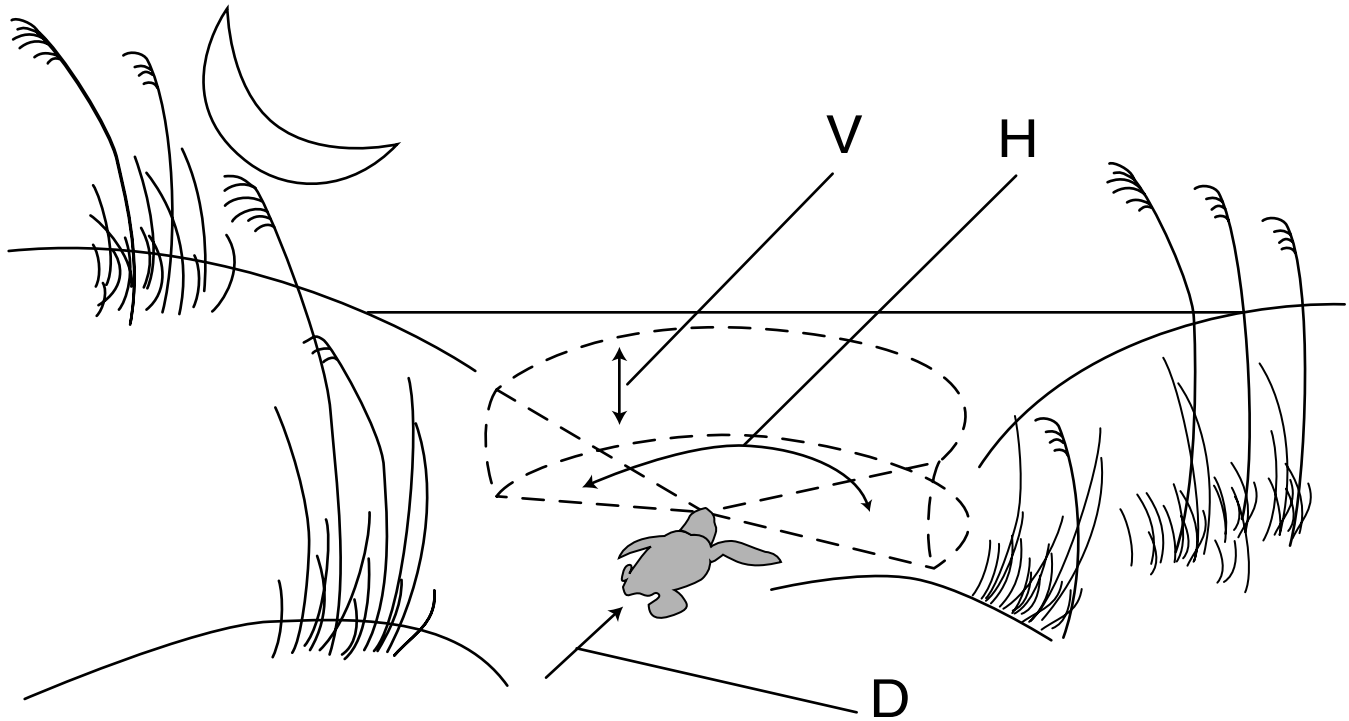

Figure 8. A hypothetical cone of acceptance that describes how a sea turtle hatchling measures the brightest direction. The vertical component of the cone (*V*) is approximately 10° – 30° from the horizon, and the horizontal component of the cone (*H*) is approximately 180° . Light within this cone of acceptance is integrated into an assessment of brightness for the direction *D*. This description is based on data from studies of green turtles, olive ridleys, and loggerheads (Verheijen and Wildschut, 1973; Witherington, 1992b). Figure adapted from Witherington (in press); used with permission.

convincing. Currently, there is some behavioral evidence that sea turtles can see color and that color may play some limited role in sea-finding.

In one of the first published discussions of sea-finding cues in hatchlings, Hooker (1911) suggested that the blue of the ocean itself may provide an attraction. The evidence used to test this hypothesis should be weighed carefully. Green turtle hatchlings do tend to prefer directions illuminated with blue light over directions illuminated with red light (Mrosovsky, 1972), but is this truly a color choice? Do hatchlings prefer the color blue, or are they simply selecting the brightest direction as determined by a detector that is most sensitive to blue wavelengths? The answer may be that both are true.

Conditioning experiments have shown that loggerheads do have some ability to discriminate among colors (Fehring, 1972). Whether loggerheads can and do use this ability in sea-finding, however, can best be determined by comparing the wavelengths a hatchling can detect best (as might be measured with ERG) with the wavelengths a hatchling prefers in orientation experiments. ERG data for the green turtle show that red light must be approxi-

mately 100 times more intense than blue light for the two colors to elicit a similar magnitude of response at the retina (Granda and O'Shea, 1972). Yet in a series of behavioral experiments using broad-band colors, Mrosovsky (1972) found that red light had to be approximately 600 times more intense than blue light in order for green turtle hatchlings to show an equal preference for the two colors. Such a bias against long-wavelength light was also demonstrated by behavioral studies in which monochromatic light was used (Figure 4; Witherington and Bjorndal, 1991a). In this study, the greatest disparity between ERG response and color preference was found in the yellow-orange region of the spectrum, near 600 nm. Although it is apparent that green turtles see yellow light well, light of this color is relatively unattractive to orienting hatchlings.

Although no ERG data currently exist for the loggerhead, the way that loggerhead hatchlings behave toward some colored light sources indicates that they too may use color cues in sea-finding. The aversion to yellow light, or xanthophobia, that loggerhead hatchlings show sets them apart from other sea turtle species. Loggerhead hatchlings are weakly attracted

to low-intensity yellow light sources but show an aversion to higher-intensity yellow light. Similar increases in the light intensity of near-ultraviolet, violet, and green light sources do not elicit a change in response from attraction to aversion, which indicates that the aversion to yellow light is related to color rather than brightness. Additional experiments with loggerheads have shown an interesting relationship between attraction to short-wavelength light and aversion to yellow light: the two responses appear to be additive. In evidence of this, Witherington (1992b) showed that adding high-intensity yellow light to an otherwise attractive light source (thereby making the light source brighter) will decrease its attractiveness to loggerhead hatchlings.

There is no empirical evidence to suggest why both loggerhead and green turtle hatchlings show little or no attraction to sources that are rich in yellow light. One hypothesis is that by reducing their attraction to yellow-rich light sources, hatchlings can avoid being misdirected by the sun or the moon. Because the rising or setting sun or moon lies within a hatchling's vertically flat acceptance cone, these celestial sources have the potential to affect hatchling orientation to some degree. However, a universal characteristic of celestial light sources is that they become yellower and redder when they are near the horizon (a sunset appears yellowish red because the blue light from the sun at dusk is attenuated by the thickness of the atmosphere that the light must pass through to reach an observer). Actually, some controversy exists as to whether the rising sun does affect sea-finding in hatchlings. Whereas Parker (1922), Ehrenfeld and Carr (1967), and Rhijn (1979) reported that loggerheads, green turtles, and hawksbill turtles are affected insignificantly by the sun on the horizon, Mrosovsky (1970), Mrosovsky and Kingsmill (1985), and Witherington (1992b) reported that loggerhead, green, and hawksbill turtles are affected. By all accounts, given its brightness, the effects of the sun on hatchling orientation seem small.

SHAPE CUES

Many authors have suggested that the patterns of light and shadow associated with visible shapes help sea turtle hatchlings find the sea. On beaches, hatchlings tend to orient toward "open areas" and "open horizons" and away from "silhouetted horizons," "dune profile," and "vegetation" (Hooker, 1911; Parker, 1922; Mrosovsky and Shettleworth, 1968; Limpus, 1971; Salmon *et al.*, 1992, 1995b).

Hatchling sea turtles' response to shape cues has been studied less extensively than their response to brightness has. To be sure, there is some debate as to

how well hatchlings on a beach can discriminate shape. Based upon the optical characteristics of a sea turtle's eye, one would expect them to see most clearly in sea water and to be relatively myopic on land (Ehrenfeld and Koch, 1967). But because hatchling eyes are small and their depth-of-focus is large, hatchlings may be able to distinguish shape well (Northmore and Granda, 1982). The most recent evidence from laboratory studies suggests that sea turtle eyes may be able to distinguish shape well enough to resolve individual stars in the sky (Northmore and Granda, 1991).

Both Limpus (1971) and Salmon *et al.* (1992) have presented convincing evidence that loggerhead and green turtle hatchlings tend to orient away from silhouettes. On most beaches this tendency would direct hatchlings away from the profile of the dune and toward the ocean. But do hatchlings respond to the shape of the dune itself or to the way the dune influences the brightest direction? By their nature, dune silhouettes darken the horizon and would be expected to influence brightest direction as hatchlings measure it. Although some effects of shape and silhouette may be independent of brightness, isolating these effects is not a straightforward process. In fact, our confidence in distinguishing shape-cue orientation from brightness-cue orientation should be only as great as our confidence in our ability to measure brightness as hatchlings do.

Determining the specific roles of shape and brightness in hatchling orientation has been attempted in cue-conflict studies. In these studies, both green turtle (Rhijn and Gorkom, 1983) and loggerhead (Witherington, 1992b, c) hatchlings tended to orient away from sets of alternating black and white stripes and toward a uniformly illuminated direction, even when the striped direction was brightest. Orientation away from a horizon that has spatial patterns of light and shadow (*i.e.*, shapes) could assist sea-finding by directing hatchlings away from the structure associated with the dune (*e.g.*, vegetation) and toward the comparatively flat and featureless ocean. However, the demonstration that hatchlings can orient with respect to shape cues does not necessarily mean that hatchlings require them for sea-finding.

The necessity of shape cues for sea-finding has been studied by depriving hatchlings of form vision (*i.e.*, the ability to discern shape). Mrosovsky and Kingsmill (1985) disrupted the form vision of loggerhead hatchlings by fitting them with waxpaper goggles and concluded that because the animals still oriented seaward, shape was not a primary cue in sea-finding. In a similar test, Witherington (1992b) placed

loggerhead hatchlings within transparent cylinders that were covered with either waxpaper or nothing at all. These hatchlings were observed as they attempted sea-finding under what might be considered "challenging" conditions—at moonset on an east-facing beach. Under these conditions, hatchlings with a clear view of their surroundings oriented seaward, whereas hatchlings having their form vision disrupted by waxpaper oriented in the general direction of the setting moon.

OTHER LIGHT CUES

In addition to intensity, wavelength, shape, and direction, light can also vary in time (have a certain periodicity) and in both space and time (display motion) and can have a unique composition of polarized light. Motion has not yet been explored as a potential sea-finding cue. Periodicity has been examined and has been found to have some influence on hatchling orientation, but only as it relates to a brightness measure. Evidence for this comes from a study in which green turtle hatchlings preferred a constant light source over a flashing one only when the off-time of the flashing source was very long (Mrosovsky, 1978). This implies that hatchlings may integrate their measures of brightness over time.

Because water tends to polarize the light reflected from it, richness of polarized light has the potential to indicate the ocean direction. However, the experiments in which hatchlings viewed their world through waxpaper but maintained a seaward orientation showed that hatchlings depend little, if at all, on polarity cues (Mrosovsky and Kingsmill, 1985). Waxpaper, in addition to obliterating form, would have also depolarized the light that hatchlings saw. Additional laboratory evidence shows that at least among loggerhead hatchlings, there is no orientation preference between sources that are polarized or unpolarized or that have different directions of polarity (e-vector direction; Witherington, 1992b).

WHEN CUES CONFLICT

Brightness cues, shape cues, and color cues (under high-illumination only) all provide information to orienting sea turtle hatchlings. Because a hatchling's environment is complex and variable, having a compound set of cues to guide even the simplest of tasks makes sense. Any single cue by itself could, under some conditions, be misleading. But do conflicting cues present a real problem in nature, and if so, how do hatchlings balance the information from these cues in order to make a correct orientation decision?

In nature, cues do conflict. Brightness measurements made on nesting beaches where hatchlings

orient to the sea show that the seaward direction is often brightest, but sometimes it is not (Rhijn, 1979; Wibbles, 1984; Witherington, 1992b). Measurements made under various conditions show that although the ocean is brightest on clear, moonless nights, the direction of the moon is brightest near moonrise and moonset (Witherington, 1992b).

Although it is not completely clear how hatchlings balance the information from conflicting orientation cues, experimental evidence indicates that this balance may be based upon the comparative strengths of the cues. In the cue-conflict experiments discussed earlier, influences of both brightest direction and shape were seen in some cases (Witherington, 1992b). Hatchlings tended to orient away from contrasting stripes even when the striped direction was twice the brightness of the uniformly lighted direction. But, when the striped direction was made three times brighter than the opposing direction, hatchling orientation became undirected, and when the striped direction was five times brighter, most hatchlings oriented toward the stripes. It seems then that orientation either away from contrasting shapes, irrespective of brightest direction, or toward the brightest direction, irrespective of contrasting shapes, depends on how strong the brightest direction happens to be. This strength of the brightest direction is known as "directivity." As the directivity of the light field a hatchling sees increases, the brightest direction becomes more pronounced, less ambiguous perhaps, and seemingly a greater orientation stimulus.

Are shape cues more important than brightness cues to orienting hatchlings? To answer this question, researchers will need to measure and compare the strengths of the two types of cues. At present, there is no common unit of measurement that can be used in making a comparison. For now, we can say that both shape cues and brightness cues are important for correct seaward orientation in a variably lighted world.

DISRUPTION OF SEA-FINDING

OBSERVATIONS OF SEA-FINDING DISRUPTION
Accounts of sea-finding disruption presented in the literature do not properly represent the vast extent of the problem. Only the most conspicuous cases are observed and reported, such as when hatchlings have been crushed on roadways (McFarlane, 1963; Philibosian, 1976; Peters and Verhoeven, 1994; REM and BEW, personal observations), burned to death in the flames of an abandoned fire (Mortimer, 1979), or led onto the playing field of a baseball game in progress (Philibosian, 1976). More often than not,

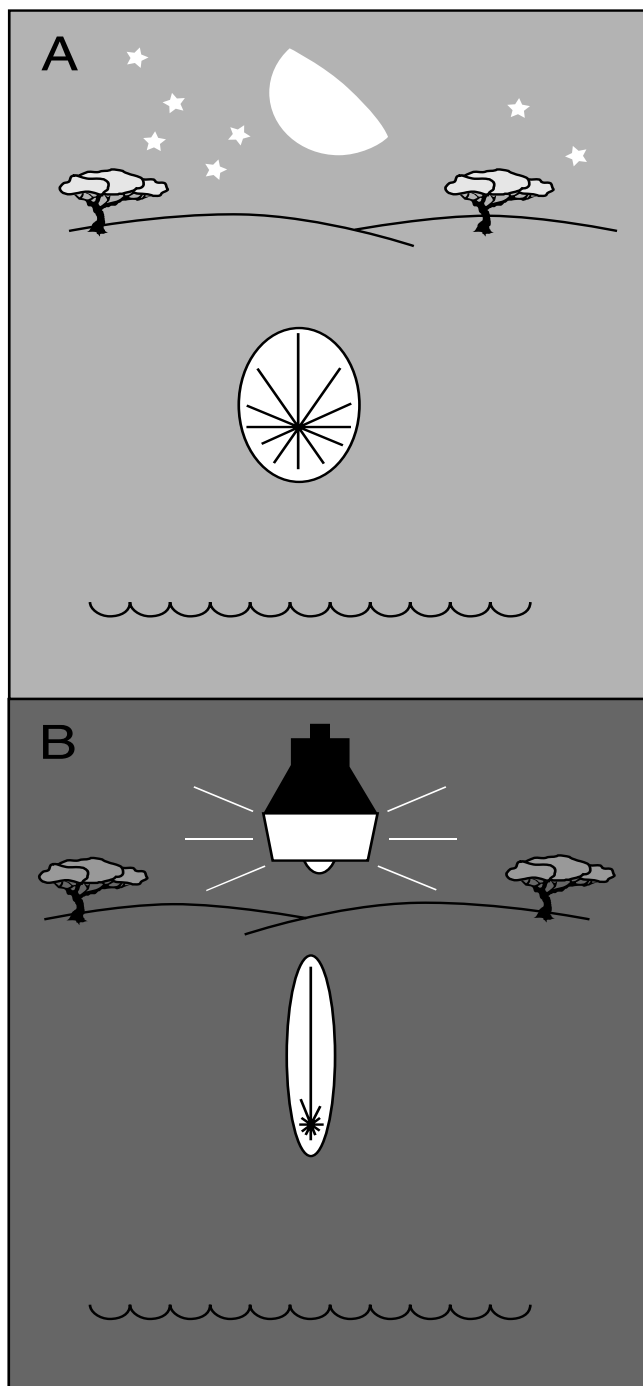

Figure 9. The directional brightness of a natural light field (A, one dominated by celestial sources) and an artificial light field (B, one dominated by a lighted luminaire) from the perspective of an observer on a beach. The length of each radiating line is proportional to the brightness of the direction. In the natural light field, the moon is conspicuous as a bright source, but it also illuminates the sky, water, and other objects. In the artificial light field, a glaring luminaire appears bright because of its closeness to the observer but does not provide enough light to illuminate other features. The luminaire produces a highly directed light field that has an overwhelming brightness in one direction.

“lost” hatchlings are preyed upon by beach crabs or shorebirds or become exhausted and dehydrated deep in nearby dune vegetation (REM and BEW, personal observations). The discovery of hundreds of dead loggerhead hatchlings beneath a mercury-vapor light at Melbourne Beach, Florida, serves as one example that indicates the cryptic nature of the problem (L. M. Ehrhart, personal communication). The number of hatchlings found in this case indicated that the light had been left on and had attracted hatchlings over many nights. As is often the case, the discovery of the pile of dried hatchlings came as a complete surprise to the caretaker of the property.

MISORIENTATION AND DISORIENTATION

Newly emerged sea turtle hatchlings crawl almost incessantly. For the most part, the effect of artificial lighting on hatchling behavior is not to alter latency, frequency, duration, or intensity of crawling, but rather to alter its efficacy—hatchlings on artificially lighted beaches tend to crawl in the wrong direction.

Hatchlings that are oriented away from the most direct ocean path are said to be “misoriented.” Hatchlings on lighted beaches are frequently misoriented, sometimes as entire groups. These groups of hatchlings leave relatively straight tracks that often stream across the beach parallel to the surf line toward an artificial light source.

Hatchlings that are “unsure” about orientation direction demonstrate their uncertainty by frequently changing direction and circling. Hatchlings lacking directed orientation are said to be “disoriented.” Similar “orientation circles” are also seen in hatchlings that have been blindfolded (Mrosofsky and Shettleworth, 1968) or placed in complete darkness (except for an infrared observation source; BEW, personal observation). Hatchlings often become disoriented by overhead light sources. Frequently, hatchlings that are misoriented toward an artificial light source become disoriented as they reach the source. Hatchlings also appear to become disoriented when they reach boundaries between artificially lighted areas and shadows on the beach. Turtles in this predicament exit the shadows toward the lighted beach sand, become exposed to the light from the artificial source itself, move toward the light source into the shadow, and may repeat this cycle until they become exhausted. This often explains the curious circling tracks that observers find in the center of the beach berm, away from any overhead light source.

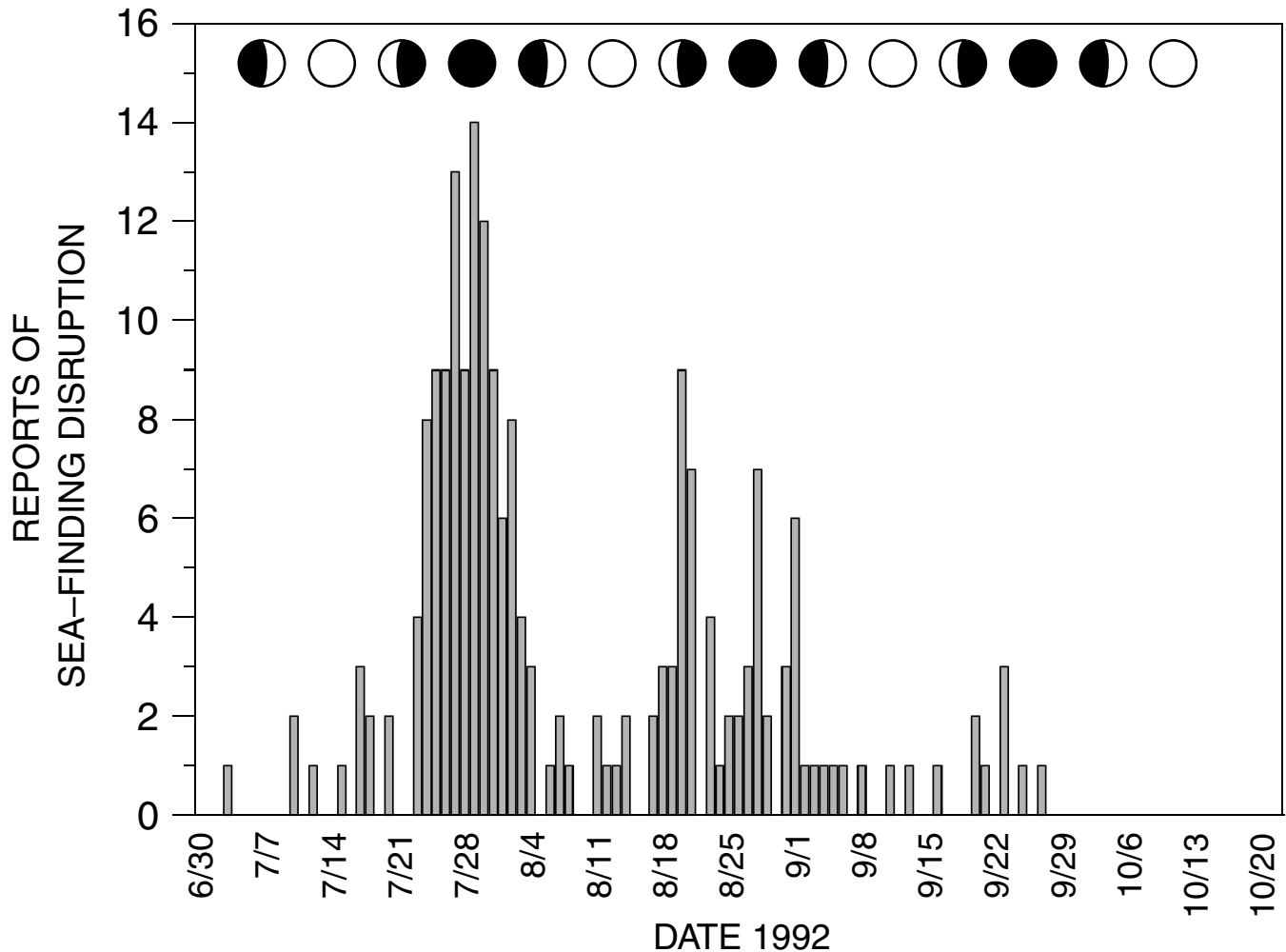

Figure 10. The timing of 201 reported cases of hatchling disorientation on Florida beaches in 1992. The circles above histogram bars show moon phase. Most cases occurred on nights on or near the new moon. The decrease in cases in September and October probably represent reduced survey efforts at the end of the nesting season. Data are from Salmon and Witherington (1995).

DIFFERENCES BETWEEN NATURAL AND ARTIFICIAL LIGHTING

Why are sea turtle hatchlings misdirected to such an extent by artificial lighting? Given the importance of light cues to hatchlings, the intuitive answer to this question is that light from artificial sources interferes with the “natural” light cues that hatchlings depend upon to orient seaward. Although hatchlings may possess a marvelous sea-finding mechanism that functions under almost any set of natural lighting conditions, this mechanism is rendered ineffective on an artificially lighted beach. But why does artificial lighting have a far greater effect on orientation than bright celestial light sources like the sun or moon do? Much of the answer to this can be found in the differences between artificial light fields and celestial light fields.

A light field is produced by a light source (or

sources) but is measured from the perspective of an observer. In essence, it is a directional picture of all the light an observer can detect. An important characteristic of light fields produced by celestial sources is that they are only moderately directed (Figure 9), which means that although there may be only one brightest direction, this direction is not tremendously brighter than other, competing, directions. These natural light fields are moderated because both the observer and the illuminated features that the observer can see are a similar distance from the light source(s). Celestial light has a distant origin and reaches an observer not only directly but also indirectly as it is scattered in the atmosphere and reflected from the features on the Earth’s surface (other competing directions). As a result, an observer experiencing a celestial light field can see brightness from many directions.

Artificial light fields are produced by sources that are less intense than celestial sources, although they can appear very bright to an observer close to the light source (Verheijen, 1958, 1978). Other features that could contribute to the brightness of the light field (sky, clouds, landscapes, *etc.*) are relatively distant and the light reflected from them is dim when compared to the brightness of the source. Consequently, an observer near an artificial light source experiences a highly directed light field that is overwhelmingly dominated by the light source. For a hatchling near a lighted luminaire on a beach, the overwhelming brightness of the light source provides a "supernormal stimulus" that overrides tendencies to orient to other visual cues.

EFFECTS OF MOON PHASE AND MOONLIGHT

Some of the myths regarding the moon's effect on hatchling emergence and sea-finding can be dispelled here. For the most part, hatchling sea turtles do not emerge from nests according to a lunar cycle. The date of emergence is determined by the date eggs were deposited in the nest and the length of the incubation period. Although nesting cycles correlated with specific moon phases have been detected in olive ridleys (Cornelius, 1986) and to a lesser extent in loggerheads (Burney *et al.*, 1991), the timing of these cycles allows for hatchling emergence during all phases of the moon. Because hatchlings may emerge when no moon is visible, they must not depend on the moon to lead them seaward. Perceptions that hatchlings emerge only during the full moon and are led seaward by its light probably originated because hatchlings are most readily observed on bright, full-moon nights.

The light of the moon does, however, have an apparent effect on the degree of sea-finding disruption caused by artificial lighting. Reports of hatchling disorientation events (including misorientation and disorientation) in Florida are most common on nights surrounding the new moon (Figure 10; Salmon and Witherington, 1995). Compared to darker nights, moonlit nights have higher levels of ambient light that may lessen the relative contribution of artificial light sources to the light fields that hatch-

lings perceive. By reducing light-field directivity, moonlight may allow hatchlings to rely on shape cues that correctly reveal the seaward direction.

SWIMMING ORIENTATION

A hatchling's best chance to survive its first few hours is to escape from the beach and swim directly out to sea, away from the predator-rich waters near the shore (Frick, 1976; Ireland *et al.*, 1978; Salmon and Wyneken, 1987; Witherington and Salmon, 1992). In the open ocean, hatchlings can conserve energy by remaining inactive, and because of their distance from shore, their risk of being swept back onto land is small.

How artificial lighting affects swimming hatchlings is not well known. Hatchling sea turtles have been observed to exit the surf onto land where lighting is nearby (Daniel and Smith, 1947a; Carr and Ogren, 1960; Witherington, 1986); however, it is not clear how long these hatchlings were in the water. Limpus (1991) reported that "thousands" of green turtle hatchlings were seen swimming in circles next to a brightly lighted boat anchored off the nesting beach at Raine Island, Australia. Hatchlings affected by such lighting may linger in the lighted water and be preyed upon by fish that are also attracted to the lighted area. These incidents may leave little or no evidence.

In laboratory settings with other cues absent, loggerhead hatchlings will swim toward an artificial light source (O'Hara, 1980; Salmon and Wyneken, 1990). However, it is apparent from other laboratory work that hatchlings depend less on light cues and more on sea-wave and magnetic cues once they enter the water (Salmon and Lohmann, 1989; Lohmann *et al.*, 1990; Salmon and Wyneken, 1990; Wyneken *et al.*, 1990). Witherington (1991) observed that loggerhead hatchlings swimming from a lighted beach had a wider pattern of dispersal than did hatchlings from unlighted beaches, but he did not see evidence of disrupted orientation comparable to that seen on land. Further work is needed to determine how lighted ships and platforms may affect the survivorship of hatchlings and their dispersal from beaches.

Assessments: Discerning Problems Caused by Artificial Lighting

Lighting Inspections

WHAT ARE LIGHTING INSPECTIONS?

During a lighting inspection, a complete census is made of the number, types, locations, and custodians of artificial light sources that emit light visible from the beach. The goal of lighting inspections is to locate lighting problems and to identify the property owner, manager, caretaker, or tenant who can modify the lighting or turn it off.

WHICH LIGHTS CAUSE PROBLEMS?

Although the attributes that can make a light source harmful to sea turtles are complex, a simple rule has proven to be useful in identifying problem lighting under a variety of conditions:

An artificial light source is likely to cause problems for sea turtles if light from the source can be seen by an observer standing anywhere on the nesting beach.

If light can be seen by an observer on the beach, then the light is reaching the beach and can affect sea turtles. If any glowing portion of a luminaire (including the lamp, globe, or reflector) is directly visible from the beach, then this source is likely to be a problem for sea turtles. But light may also reach the beach indirectly by reflecting off buildings or trees that are visible from the beach. Bright or numerous sources, especially those directed upward, will illuminate sea mist and low clouds, creating a distinct glow visible from the beach. This “urban skyglow” is common over brightly lighted areas. Although some indirect lighting may be perceived as nonpoint-source light pollution, contributing light sources can be readily identified and include sources that are poorly directed or are directed upward. Indirect lighting can originate far from the beach.

Although most of the light that sea turtles can detect can also be seen by humans, observers should realize that some sources, particularly those emitting near-ultraviolet and violet light (e.g., bug-zapper lights, white electric-discharge lighting) will appear brighter to sea turtles than to humans. A human is also considerably taller than a hatchling; however, an observer on the dry beach who crouches to the level of a hatchling may miss some lighting that will affect turtles. Because of the way that some lights are par-

tially hidden by the dune, a standing observer is more likely to see light that is visible to hatchlings and nesting turtles in the swash zone.

HOW SHOULD LIGHTING INSPECTIONS BE CONDUCTED?

Lighting inspections to identify problem light sources may be conducted either under the purview of a lighting ordinance (see Appendix H and the section below on sea turtle lighting ordinances) or independently. In either case, goals and methods should be similar.

GATHER BACKGROUND INFORMATION

Before walking the beach in search of lighting, it is important to identify the boundaries of the area to be inspected. For inspections that are part of lighting-ordinance enforcement efforts, the jurisdictional boundaries of the sponsoring local government should be determined. It will help to have a list that includes the name, owner, and address of each property within inspection area so that custodians of problem lighting can be identified. Plat maps or aerial photographs will help surveyors orient themselves on heavily developed beaches.

PRELIMINARY DAYTIME INSPECTIONS

An advantage to conducting lighting inspections during the day is that surveyors will be better able to judge their exact location than they would be able to at night. Preliminary daytime inspections are especially important on beaches that have restricted access at night. Property owners are also more likely to be available during the day than at night to discuss strategies for dealing with problem lighting at their sites.

A disadvantage to daytime inspections is that fixtures that are not directly visible from the beach will be difficult to identify as problems. Moreover, some light sources that can be seen from the beach in daylight may be kept off at night and thus present no problems. For these reasons, daytime inspections are not a substitute for nighttime inspections.

Descriptions of light sources identified during daytime inspections should be detailed enough so that anyone can locate the lighting. In addition to a general description of each luminaire (e.g., HPS floodlight directed seaward at top northeast corner of

the building at 123 Ocean Street), photographs or sketches of the lighting may be necessary. Descriptions should also include an assessment of how the specific lighting problem can be resolved (*e.g.*, needs turning off; should be redirected 90° to the east). These detailed descriptions will show property owners exactly which luminaires need what remedy.

NIGHTTIME INSPECTIONS

Surveyors orienting themselves on the beach at night will benefit from notes made during daytime surveys. During nighttime lighting inspections, a surveyor walks the length of the nesting beach looking for light from artificial sources. There are two general categories of artificial lighting that observers are likely to detect:

1. **Direct lighting.** A luminaire is considered to be direct lighting if some glowing element of the luminaire (*e.g.*, the globe, lamp [bulb], reflector) is visible to an observer on the beach. A source not visible from one location may be visible from another farther down the beach. When direct lighting is observed, notes should be made of the number, lamp type (discernable by color; Appendix A), style of fixture (Appendix E), mounting (pole, porch, *etc.*), and location (street address, apartment number, or pole identification number) of the luminaire(s). If exact locations of problem sources were not determined during preliminary daytime surveys, this should be done during daylight soon after the nighttime survey. Photographing light sources (using long exposure times) is often helpful.
2. **Indirect lighting.** A luminaire is considered to be indirect lighting if it is not visible from the beach but illuminates an object (*e.g.*, building, wall, tree) that is visible from the beach. Any object on the dune that appears to glow is probably being lighted by an indirect source. When possible, notes should be made of the number, lamp type, fixture style, and mounting of an indirect-lighting source. Minimally, notes should be taken that would allow a surveyor to find the lighting during a follow-up daytime inspection (for instance, which building wall is illuminated and from what angle?).

WHEN SHOULD LIGHTING INSPECTIONS BE CONDUCTED?

Because problem lighting will be most visible on the darkest nights, lighting inspections are ideally conducted when there is no moon visible. Except for a few nights near the time of the full moon, each night

of the month has periods when there is no moon visible. Early-evening lighting inspections (probably the time of night most convenient for inspectors) are best conducted during the period of 2–14 days following the full moon. Although most lighting problems will be visible on moonlit nights, some problems, especially those involving indirect lighting, will be difficult to detect on bright nights.

A set of daytime and nighttime lighting inspections before the nesting season and a minimum of three additional nighttime inspections during the nesting-hatching season are recommended. The first set of day and night inspections should take place just before nesting begins. The hope is that managers, tenants, and owners made aware of lighting problems will alter or replace lights before they can affect sea turtles. A follow-up nighttime lighting inspection should be made approximately two weeks after the first inspection so that remaining problems can be identified. During the nesting-hatching season, lighting problems that seemed to have been remedied may reappear because owners have been forgetful or because ownership has changed. For this reason, two midseason lighting inspections are recommended. The first of these should take place approximately two months after the beginning of the nesting season, which is about when hatchlings begin to emerge from nests. To verify that lighting problems have been resolved, another follow-up inspection should be conducted approximately one week after the first midseason inspection.

WHO SHOULD CONDUCT LIGHTING INSPECTIONS?

Although no specific authority is required to conduct lighting inspections, property managers, tenants, and owners are more likely to be receptive if the individual making recommendations represents a recognized conservation group, research consultant, or government agency. When local ordinances regulate beach lighting, local government code-enforcement agents should conduct lighting inspections and contact the public about resolving problems.

WHAT SHOULD BE DONE WITH INFORMATION FROM LIGHTING INSPECTIONS?

Although lighting surveys serve as a way for conservationists to assess the extent of lighting problems on a particular nesting beach, the principal goal of those conducting lighting inspections should be to ensure that lighting problems are resolved. To resolve lighting problems, property managers, tenants, and owners should be given the information they need to make proper alterations to light sources. This information

should include details on the location and description of problem lights, as well as on how the lighting problem can be solved. One should also be prepared to discuss the details of how lighting affects sea turtles. Understanding the nature of the problem will motivate people more than simply being told what to do.

Monitoring Sea Turtle Behavior

In part, the behavior of nesting sea turtles and their hatchlings on the beach can be monitored by studying the tracks they leave in the sand. This evidence can reveal how much and where nesting occurs and how well oriented hatchlings are as they attempt to find the sea from their nest. Monitoring this behavior is one way to assess problems caused by artificial lighting, but it is no substitute for a lighting inspection program as described above. Many lighting problems may affect sea turtles and cause mortality without their leaving conspicuous track evidence on the beach.

SEA TURTLE NESTING

On many beaches, sea turtle biologists make early-morning surveys of tracks made the previous night in order to gather information on nesting. With training, one can determine the species of sea turtles nesting, the success of their nesting attempts, and where these attempts have occurred. These nesting surveys are one of the most common assessments made of sea turtle populations.

Because many factors affect nest-site choice in sea turtles, monitoring nesting is a not a very sensitive way to assess lighting problems. However, changes that are observed in the distribution or species composition of nesting can indicate serious lighting problems and should be followed with a program of lighting inspections if one is not already in place.

HATCHLING ORIENTATION

Although hatchlings are more sensitive to artificial lighting than are nesting turtles, the evidence they leave behind on the beach is less conspicuous. Evidence of disrupted sea-finding in hatchlings (hatchling disorientation) can vastly underrepresent the extent of a lighting problem; however, this evidence can be useful in locating specific problems between lighting inspections. There are two ways one can use hatchling-orientation evidence to help assess lighting problems:

HATCHLING-ORIENTATION SURVEYS

Of the two methods, hatchling-orientation surveys, which involve measuring the orientation of hatchling tracks at a sample of sites where hatchlings have emerged, provide the most accurate assessment. Because the jumble of hatchling tracks at most emergence sites is often too confused to allow individual tracks to be measured, simple measures of angular range (the width that the tracks disperse) and modal direction (the direction that most hatchlings seem to have gone) are substituted. If the sampling of hatchling emergence sites does not favor a specific stretch of beach or a particular time of the lunar cycle, data from these samples can be an accurate index of how well hatchlings are oriented (Witherington *et al.*, 1996).

HATCHLING-DISORIENTATION REPORTS

Although many cases of hatchling disorientation go unnoticed, some are observed and reported. The evidence of such events includes numerous circling tracks, tracks that are directed away from the ocean, or the carcasses of hatchlings that have succumbed to dehydration and exhaustion. Because reporters often discover this evidence while conducting other activities, such as nesting surveys, the events reported often include only the most conspicuous cases. Although these reports have a distinct coverage bias, they can still yield valuable information.

Hatchling-disorientation reports can help researchers immediately identify light-pollution problems. Although not every hatchling that is misled by lighting may be observed and reported, each report constitutes a documented event. When reports are received by management agencies or conservation groups, action can be taken to correct the light-pollution problem at the specific site recorded in the report. To facilitate the gathering of this information, standardized report forms should be distributed to workers on the beach who may discover evidence of hatchling disorientation. The following is a list of information that should be included on a standardized hatchling-disorientation report form:

1. Date and time (night or morning) that evidence was discovered.
2. Observer's name, address, telephone number, and affiliation (if any). The reporter may need to be contacted so that information about the event can be verified and the site can be located.
3. Location of the event and the possible light sources

responsible. Written directions to the locations should be detailed enough to guide a person unfamiliar with the site. The reporter should judge which lighting may have caused the sea-finding disruption, a decision that may involve knowledge about lighting that was on during the previous night and the direction(s) of the tracks on the beach. If possible, the type of lighting responsible

should be identified (*e.g.*, a high-pressure-sodium street light).

4. The number of hatchlings of each species involved in the event. Unless carcasses or live hatchlings are found, the species and numbers involved will be an estimate.
5. Additional notes about the event.

Solutions: Solving Problems Caused by Artificial Lighting

Light as a Pollutant

Light pollution has widespread effects. The terms “light pollution” and “photopollution” were originally used by astronomers (Dawson, 1984; Eakin, 1986) to describe the light that obliterates our scientific and recreational view of the night sky. Many of the same light sources that interfere with our enjoyment of the heavens on nightly beach walks also deter nesting and disrupt orientation in sea turtles. The biological effects of light pollution are just beginning to be realized and are not limited to sea turtles. Many animals—such as migrating birds and night-flying insects—depend on natural light for cues that guide orientation and are well-known victims of artificial lighting (Verheijen, 1985; Witherington, in press).

Solving problems caused by light pollution can be very different from solving problems caused by other pollutants. For instance, in theory, harmful light can be eliminated instantaneously by flipping a switch at the source. Light does not linger in the environment as do many polluting substances. However, some difficulty lies in recognizing light pollution and in agreeing upon which artificial lighting constitutes problem lighting. One person’s environmental threat may be another person’s safety and security.

It may help to think of light pollution as being artificial light that is out of place. More often than not, light that is located in the area it was meant to illuminate causes little harm. This is certainly true for sea turtle nesting beaches: artificial light that illuminates dune properties without reaching the nesting beach itself is not a threat to sea turtles.

The most readily accepted strategy for solving light-pollution problems is to manage light rather than prohibit it. In most cases, light that causes problems for sea turtles has “spilled over” from sites it was intended to illuminate; this light “spillage” does not serve a useful purpose and should be managed. A program of light management can make it possible to solve light-pollution problems without resorting to “just say no” policies that may be intimidating to the public.

USING BEST AVAILABLE TECHNOLOGY

Light management for conserving sea turtles must have an identifiable goal; that is, light must be managed to some level that conservationists can recog-

nize. Unfortunately, there is no level of light intensity that one may use as this criterion. The level of artificial brightness necessary to deter nesting or misorient hatchlings varies greatly with the level of ambient light (moonlight) and with the availability of other visual cues (*e.g.*, the amount of dune). Consequently, there is no one acceptable level of light for every sea turtle nesting beach under every set of lighting conditions.

Given the uncertainty over how to measure acceptable light, it is most productive to simply minimize light pollution as best we can. This is the concept behind the use of best available technology (BAT: a common strategy for reducing other forms of pollution by using the best of the pollution-reduction technologies available). Best available technology forms the basis of light management methods that reduce the effects of artificial lighting to the greatest extent practicable. Although there is no single “turtle-friendly” luminaire that would be best for all applications, there are methods one can use, and a set of characteristics that light sources should have, in order to minimize the threat of light pollution for sea turtles. As presented below, these light-management tactics include selecting some lights to be turned off, controlling light so that the level reaching the beach is minimized, and ensuring that the light that does reach the beach is the least disruptive color.

Effective Methods for Managing Light

TURN OFF PROBLEM LIGHTS

Any strategy to reduce light pollution should begin with identifying those problem light sources (as defined previously in “Assessments”) that can be switched off or eliminated. Many light sources illuminate areas that do not need to be lighted. These unnecessary light sources include the following:

1. Light sources illuminating areas that require no security. This includes the beach itself in most cases. Ocean beaches are often in public, not private, ownership and are not areas where property is normally stored.
2. Light sources that illuminate areas that are vacant or where there is no foot traffic.
3. Decorative lighting. This category of lighting usually has limited use for any purpose other than aes-

thetic enhancement. Decorative lighting near nesting beaches may be much more harmful to sea turtles than it is useful to people.

4. Light sources that provide more than adequate illumination for a particular function. Light illuminance levels necessary for safety and security are rather low (0.2–1.0 footcandles or 2–11 lux, recommended for fence security and parking areas) compared with the illuminance necessary for detailed work, comfortable reading, or outdoor entertainment (100–300 footcandles or 110–320 lux) (Kaufman and Christensen, 1987).

Unnecessary light sources near sea turtle nesting beaches should be eliminated, and the number of light sources that provide more than adequate illumination should be reduced. Lighting that is necessary for safety or security can be used when needed during early-evening hours and switched off the remainder of the night (see notes on timers and motion detectors below). Items valuable enough to require security lighting should be moved away from the beach.

Switching lights off can be the simplest, cheapest, and most straightforward way to solve lighting problems. Turning out the lights will result in energy, as well as sea turtle, conservation. Usually, property owners are able to switch lighting off on their own; however, large outdoor luminaires and the poles they are mounted on are sometimes leased from a power company and must be switched off by authorized company personnel at the request of the customer paying the electricity bill.

MINIMIZE BEACH LIGHTING FROM OUTDOOR SOURCES

Beach lighting from outdoor sources can be minimized in a number of ways that allow the function of the lighting to be retained or even enhanced:

1. Turn the lighting off, or better yet, remove the luminaire. Sometimes this is the only solution to the problem, and it is almost always the simplest and least expensive solution. Lighting does not need to be extinguished year-round, only during the nesting-hatching season.
2. Reduce the wattage of problem lighting. For a given lamp type (*e.g.*, high-pressure sodium vapor) and style of fixture (*e.g.*, floodlight), reducing the wattage of the luminaire (or lamp) will reduce the amount of light emitted. When changing lamp types or fixture styles, the manufacturer's data on luminance (typically given in lumens) should be consulted. A table outlining efficiency (lumens/watt) of various light sources is given in Appendix B.
3. Substitute luminaires that are better focused so that light can be concentrated where it is most needed. Lower-wattage directional luminaires can replace higher-wattage multidirectional luminaires. Luminaires should not be directed onto the nesting beach or onto any object visible from the beach (see Appendices D–F).
4. Shield light sources from the nesting beach. To be effective, light shields should be completely opaque, sufficiently large, and positioned so that light from the shielded source does not reach the beach. In most cases, light shields can be fashioned from materials that are inexpensive and easily obtained. Aluminum and galvanized-steel flashing, plywood, and some opaque plastics make excellent light shields. An effective, simple, and inexpensive way to shield luminaires with hemispherical globes (*e.g.*, cobrahead fixtures) is to line the inside of the seaward half of the globe with household aluminum foil (the foil is not likely to remain on the outside of the globe). Attempts to shield light by fastening tinted acrylic or acetate to luminaires or painting their globes are generally not effective because these materials are not sufficiently opaque. Tar-paper shields are effective only for a short time because they do not weather well. Good shielding should provide a cutoff angle of 90° or more. Although commercial light shields are available for some common outdoor fixtures (Luminaire Technologies, Inc., Hubbell Lighting, Inc.; Appendix G), customized light shields are often needed because luminaires come in so many different designs. Changing a light fixture to a more directional style is almost always a more efficient and permanent solution than shielding is.
5. Recess luminaires into roof soffits. Recessed sources will be more directional and, if directed downward, will be less visible from the beach than multidirectional lighting is (see Appendices D, E).
6. Lower pole-mounted luminaires or use low-mounted luminaires with louvered, bollard-type fixtures as a substitute for pole-mounted lighting. The lower a light source is mounted, the smaller the area it will illuminate. In addition, sources mounted lower will tend to have a greater degree of shielding from the beach by objects on the dune (vegetation, buildings, *etc.*). Sources mounted high on poles near the beach can be very difficult to shield from the beach. The post-like stature of bollard luminaires and the light-directing louvers with which they can be fitted make them ideal for keeping light close to the ground and off the beach.

7. Redirect luminaires away from the nesting beach. Even sources that are poorly directional can be redirected so that most of their brightness is pointed away from the beach.
8. Reposition luminaires to take advantage of natural light screens. Necessary luminaires should be positioned on the landward side of any buildings or vegetation.
9. Install timers to switch off lighting when it is no longer needed in the evening. This tactic by itself is only minimally effective in solving lighting problems because both nesting and hatchling emergence can occur throughout the night. To be most effective, timers should be set to turn lights off in the early evening, no more than one hour after dusk. People tend to function poorly as "timers" because of forgetfulness, procrastination, and other human foibles.
10. Install motion-detector switches. Lighting connected to a motion-detector switch comes on when the fixture itself is approached and then switches off after a set time following the last detected motion. Thus, the light source is on only when it is needed for safety or security. If possible, the length of time that lighting remains on should be set at no more than 30 seconds. This type of lighting should not be used in high-traffic areas visible from the beach. Motion-detector switches are generally a better solution to lighting problems than timers are, are relatively inexpensive, and are widely available (Appendix D). However, motion detectors can be used only with incandescent lighting (yellow bug-light bulbs work well with motion detectors).
11. Install visors or louvers to stadium lighting. Stadium lighting—intense broad-spectrum lighting that is typically mounted as multiple units on tall poles—can pose lighting problems that are particularly difficult to solve. This type of lighting should not be used near sea turtle nesting beaches during the nesting-hatching season. Because stadium lighting tends to be both outwardly directed and intense, it can produce a glow that affects nesting beaches many kilometers away. This glow can be reduced by fitting individual luminaires with louvers or visors that reduce the amount of light shining upward and laterally (Hubbell Lighting, Inc.; Appendix G).
12. Replace conspicuous lighting on beach-access ramps with hidden, walkway-only lighting. Because lighting meant to illuminate beach-access ramps is often conspicuously located out on the beach itself, it can be difficult to shield properly. Other than turning this lighting off, the

best solution to the problems caused by this lighting is to use hidden light sources that light only the walking surface of the ramp. A good way to hide ramp lighting is to use small light sources (e.g., light-emitting diodes) within strips that are sunken within grooves along the edges of the ramp's walking surface (Appendix E).

13. Plant native dune vegetation as a light screen. Planting light-blocking vegetation on the primary dune can help alleviate problems caused by light that is not managed by the techniques outlined above. To be most effective, vegetation should be near the crest of the dune closest to the beach, which is where woody, well-established vegetation normally grows. Salt-tolerant, bushy, densely leaved native plants are the most suitable. See the discussion on light screens below.

MINIMIZE BEACH LIGHTING FROM INDOOR SOURCES

Light from indoor sources can also cause problems for sea turtles. The criteria for identifying problems caused by indoor lighting are the same as those for identifying problems caused by outdoor lighting. Indoor light is a problem if it is visible from the beach.

Indoor lighting from buildings that are close to the beach, are very tall, or have large sea-side windows causes the greatest problem for sea turtles. Because indoor lighting is usually not meant to light the outdoors, the unwanted effects of indoor lighting can easily be eliminated without compromising the intended function of the lighting by doing the following:

1. Turning off lighting in rooms that are not in use. Reminder notices placed on switches in oceanfront rooms can help in this effort.
2. Relocating moveable lamps away from windows that are visible from the beach.
3. Tinting or applying window treatments to windows visible from the beach so that light passing from inside to outside is substantially reduced. A good tinted glass or window-tinting treatment will reduce visible light from the inside to 45% or less (transmittance $\leq 45\%$). Window glass may be either tinted during its manufacture or tinted later with an applied film. Window treatments (shading materials) are less permanent and can reduce light transmittance more than tints and films can. A complete blocking of light is ideal. See Appendix G for companies offering tinted glass and window treatments.
4. Closing opaque curtains or blinds after dark to

completely cover windows visible from the beach. This is an inexpensive solution because most home windows have curtains or blinds to provide privacy to the occupants.

USE ALTERNATIVE, LONG-WAVELENGTH LIGHT SOURCES

Where efforts to dim, redirect, or block light have not been entirely effective, some errant light may reach the beach. An additional strategy to reduce the effects of artificial lighting is to ensure that any light reaching the beach has spectral properties that make it minimally disruptive to sea turtles. Minimally disruptive light sources have a spectral distribution that excludes short-wavelength (ultraviolet, violet, blue, and green) light. These long-wavelength light sources will have a minimal effect on sea turtles, but because they are not completely harmless, they should not be used without light-management techniques.

LOW-PRESSURE SODIUM VAPOR

The spectral properties of low-pressure sodium-vapor (LPS) lighting make this type of lamp the least disruptive to sea turtles among commonly used, commercially available light sources. This assessment comes from studies of nesting and hatchling loggerheads and green turtles, along with limited evidence from studies of hatchling hawksbills and olive ridleys. Because light from LPS sources is not completely ignored by sea turtles, LPS should be considered as a substitute for more disruptive light sources rather than as a replacement for beach-darkening efforts.

LPS light has greater effects on some species than on others. Loggerhead hatchlings have not been observed to have sea-finding substantially disrupted by LPS lighting in the field, whereas green turtle hatchlings are substantially affected under some conditions. Although LPS lighting is predicted to have a minimal effect on loggerhead hatchlings, it is not true that LPS—because of the loggerhead hatchlings' aversion to yellow light—will reduce the attraction of other, adjacent, lights on the nesting beach. To improve loggerhead sea-finding on a lighted beach, illuminance from additional LPS lighting would need to be considerably higher than what is typical for outside lighting.

YELLOW FILTERS, BUG LIGHTS, AND RED LED'S
Lamps that are tinted yellow to reduce the emission of insect-attracting short-wavelength light (bug lights) can also be minimally disruptive to sea turtles. Bug lights are poorer alternatives than LPS lighting

but are less expensive (initially) and more widely available than LPS lighting. True bug lights are incandescent lamps, but some yellow-tinted fluorescent tubes are available (Appendix C) and should be used in place of white fluorescent tubes.

Amber or yellow filters installed in light fixtures vary greatly in effectiveness and can fade, increasing the transmission of short-wavelength light over time. Yellow, dichroic "long-pass" filters are an exception to this rule—they exclude short wavelengths well and generally do not degrade with time (but can degrade with high heat). To affect sea turtles the least, dichroic filters should exclude all wavelengths (have a stop-band) below 520 nm.

Red light-emitting diodes (LEDs) are too small to light large areas but can be used for walkways and steps. The red light of LEDs remains a true, narrow-band red for the life of the lamp and is probably one of the light sources least visible to sea turtles. The red light from LEDs has the added benefit of not degrading the night vision of people visiting the beach. As people walk to the beach along a pathway lighted with red LED lamps, their eyes can adjust to the darkness, leaving them better able to see by moonlight and starlight once they reach the unlighted beach.

HOW TO CHOOSE AN ALTERNATIVE LIGHT SOURCE

Selecting appropriate alternative lighting may seem to be a complex task. For example, which would be least harmful to sea turtles, a 15-watt white bulb or a 35-watt LPS luminaire? Unfortunately, we have no reliable formula that can be used to calculate how much each light source will affect sea turtles. We do know, however, that if spectral emissions are equivalent, reducing intensity will reduce effects, and if intensities are similar, substituting less attractive sources (like LPS) will also reduce effects. A sound strategy, therefore, would be to reduce effects on sea turtles by manipulating both intensity and color. As few lights as practicable should be used, and for lighting applications that are deemed essential, long-wavelength light sources (LPS, bug lights, etc.) should replace more disruptive light sources and intensity should be reduced by using lamps of minimal wattage that are housed within well-directed fixtures aimed down and away from the beach. Rather than attempt to answer the example question posed above, one should explore additional available technology that will best suit one's lighting needs. If a 15-watt white bulb is truly sufficient for the lighting requirement, then a 15- to 25-watt bug-light bulb may be a more appropriate choice than a 35-watt LPS

luminaire, which would emit approximately 20 times the light of the white bulb.

USE LIGHT SCREENS AND ENHANCE DUNE PROFILE

Both laboratory and field experiments have suggested that the silhouette of the dune can influence sea-finding in hatchlings (Limpus, 1971; Salmon *et al.*, 1992), and it is clear that sea-finding problems are exacerbated where the dune profile is low or the dune is sparsely vegetated (Ferris, 1986; Witherington, 1990; Reiners *et al.*, 1993). Whether by providing visual cues, blocking light, or both, enhancing the silhouette of the dune can reduce lighting problems. Methods include the following:

1. Planting native vegetation on the dune. Unlike artificial light screens, vegetation will grow, enhance the dune habitat for other animals, and may provide more natural orientation cues for hatchlings.
2. Erecting artificial light screens on the dune where immediate, short-term light blocking is needed. Artificial screens should be positioned so that they do not impede nesting. Sturdy "shade cloth" and "privacy fencing" can make effective light screens. Artificial light screens can be used to block light until planted vegetation thickens to fill in gaps.
3. Filling in and replanting dune cuts, pathways, and washout areas. Misoriented hatchlings and adult turtles often exit the beach through these lighted gaps in the dune.
4. Providing emerging hatchlings shielded pathways from nest to surf. On the loggerhead nesting beach at Cape Canaveral Air Force Station, Florida, workers have been able to correct hatchling orientation in lighted areas by shading the dune side of nests and laying 10-cm-high walls of lumber from nest to high-tide line (Leach, 1992). These tactics should be used only as stop-gap measures to reduce hatchling mortality while other light-management efforts are made.

A COMPREHENSIVE STRATEGY FOR MINIMIZING EFFECTS OF ARTIFICIAL LIGHTING

There are many options for lessening the effects of artificial lighting on sea turtles, but in order to have them employed, a comprehensive strategy is needed to educate stakeholders, pass legislation, enforce laws, and monitor the nesting beach.

1. Education. Efforts should begin with making those

able to solve lighting problems (individuals, corporations, or governments) aware of the problems and possible solutions. Public awareness is a prerequisite for legislative action and can foster results that extend beyond what can be mandated by government. Many of the organizations listed in Appendix I are authorities on educating the public on conservation issues. Stories in the news media, distribution of pamphlets and fliers (see Appendix I for sources), presentations at community gatherings, and door-to-door campaigns can make the public aware of the need for darker nesting beaches (Limpus *et al.*, 1981; Witherington, 1986).

Well-rounded and long-term educational efforts should include the next generation of sea turtle conservationists. Nurturing in school-age children an appreciation of sea turtles and other features of the natural world is a vital conservation investment.

2. Legislation. While public awareness is important for fostering beach-darkening efforts, light-management legislation is often necessary to complete the task. Light-management laws represent serious commitment to protecting sea turtles from artificial lighting and ensure that this conservation effort will be community-wide. See Appendix H and the discussion on legislation below.
3. Prevention and enforcement efforts. It is far easier to solve light-pollution problems during preliminary planning, before projects are constructed and before lighting is installed. Legislation should require that a central, knowledgeable authority review development plans so that any new lighting near a nesting beach does not become a problem for sea turtles. Solutions to existing lighting problems should also be enforced. Where existing lighting problems are complex or difficult to solve, grace periods can be granted; however, flagrant lighting problems caused by easily identifiable sources should be remedied quickly. Issuing warnings and levying fines can ensure that lighting problems are solved promptly. Ideally, warnings should be issued prior to the nesting and hatchling seasons so that problems can be solved before nesting is deterred and hatchlings are killed.
4. Know your nesting beach. Lighting problems can be detected more quickly if observers are familiar with the activities of sea turtles and humans on the beach. Lighting problems can be cryptic. Results of lighting inspections, nesting surveys, and hatchling disorientation reports should be assessed regularly.

Lighting Ordinances: How an Idea Becomes a Law

Acts of local, state, and national governments are often essential to ensure that light management on nesting beaches, justified by scientific information and supported by the public, becomes a reality. By adopting light-management legislation, government makes a long-term commitment to protect sea turtles from the harmful effects of artificial lighting. Light-management laws are necessary because some individuals will not correct lighting problems unless they are required to do so. Legislation can force action when needed and, on many nesting beaches, may be the only means to completely resolve light-pollution problems.

In addition to providing a public mandate, legislation can establish specific criteria for determining which artificial light sources constitute a problem and how this lighting should be modified to resolve the problem. Legislation ensures that lighting problems are handled in a fair and even-handed manner throughout coastal areas.

What follows is a step-by-step guide to initiating, passing, and implementing legislation to protect sea turtles from light pollution. The strategy presented is largely based upon successful efforts in Florida, USA, but it provides a framework that can be generally applied elsewhere.

1. BECOME FAMILIAR WITH THE ISSUES

Those accepting responsibility for promoting lighting legislation should become familiar with all related issues: specific effects of artificial lighting on sea turtles, recommended methods of correcting problem lights, local nesting patterns of sea turtles, observed and/or potential lighting problems on local beaches, and details of existing lighting legislation that can be used as a model.

Van Meter (1992) provides a good general overview of sea turtle biology for nonbiologists, and the National Research Council (1990) offers a detailed account of sea turtle conservation issues. For some beaches, specific information on sea turtle nesting, hatchling orientation, and existing lighting can be obtained from local researchers and conservationists or from published reports. For poorly known beaches, much of this information will need to be gathered. General information on lighting and its effect on sea turtles can be found within this manual. Various environmental groups, biologists, and resource managers (see Appendix I) may be contacted for information concerning legislation adopted in other areas. "Florida's Model Standards for Beach-

front Lighting" are included in this manual (Appendix H) as an example of minimum guidelines for protecting sea turtles from the effects of lighting.

2. DEVELOP A SUMMARY DOCUMENT OF RELEVANT LOCAL ISSUES

It is helpful to summarize relevant information in a single document that can be used to develop presentations to the public and to educate government officials. Ask a person or group familiar with lighting issues to review the summary to ensure that all of the pertinent information is covered.

3. DEVELOP A PRESENTATION

A presentation developed from the summary document should be directed toward those unfamiliar with the subject. Remember that many in the audience will know little about sea turtles, how threatened they are, and why they need to be protected. Have succinct answers ready for the most basic questions, as well as for the most difficult ones (see Appendix J).

A good presentation should include a brief description of sea turtles and their plight. Be sure to distribute materials with photographs or to project slides that show what sea turtles look like. Supportive materials (*e.g.*, slides, pamphlets, booklets) may be available from environmental groups or government agencies (see Appendix I). The presentation should clearly justify the need for legislation. Use the presentation as an opportunity to allay fears. Point out that light-management legislation is not meant to prohibit lighting near the beach; the goal of light management is to preserve useful light and reduce harmful light. Address the misconceptions that lighting modifications will cause beaches to become less safe and will cost large sums of money (see Appendix J). Lastly, review in the presentation some practical methods for assessing and correcting problem lighting. Because it may take years to pass effective legislation, the education provided by these public presentations may be the only impetus for improving local lighting conditions while legislation is pending.

4. WRITE A PRELIMINARY DRAFT OF THE LEGISLATION

A preliminary draft of legislation should address all of the relevant issues heretofore discussed. The "Florida Model Standards for Beachfront Lighting" (Appendix H) and legislation from other areas may be used as guides for writing the draft legislation. A person or group familiar with lighting issues should review the draft to make sure that all important points are covered.

5. SOLICIT SUPPORT FOR LEGISLATION

Public support for lighting legislation is essential. In small communities, support can be garnered at town meetings and from individual contacts with coastal residents and business owners. In larger communities, one should begin public-awareness campaigns on a broad scale by making presentations to local environmental groups, civic organizations, homeowners associations, and other groups, especially those with members who may be affected by the legislation. Pamphlets or fliers distributed by hand or by mail will reach many of those not attending meetings and presentations.

Be patient and diplomatic when interacting with an audience. Concerns of those who may be skeptical, whether justified or imagined, should be thoroughly addressed. Responses to many common questions and concerns about beach-darkening efforts are listed in Appendix J.

Presentations should be reevaluated regularly based on audience reaction. If a particular concept is obviously not clear to the audience at the end of the presentation, then the explanation of that concept probably needs to be modified.

The internet, radio, television, and the press can be quite valuable in getting the message out. As in other presentations to the public, it is helpful to give a short, standardized message that includes the basic elements discussed above. It is also valuable to distribute written news releases to the electronic and print media.

6. EDUCATE GOVERNMENTAL STAFF

Whether the need for lighting legislation is originally identified by government planning or environmental staff or it has been introduced by an outside group, the knowledgeable support of local government staff is critical. If staff are not well versed in the relevant issues, they should be provided with the pertinent background information (the summary document discussed above, a copy of this manual, names and addresses of sea turtle biologists familiar with lighting issues, *etc.*).

Local government staff can be extremely helpful by providing guidance on how to properly format legislation and how to best approach government officials in order to pass legislation. Unfortunately, government environmental and planning departments may be greatly understaffed and may be overwhelmed by new issues. For this reason, assist the staff whenever possible, avoid unnecessary demands on their time, and by all means, demonstrate an appreciation for their efforts.

7. EDUCATE ELECTED OFFICIALS

Personal meetings with elected officials may be very effective in gaining support for legislation, but certain guidelines should be followed. First and foremost, be well prepared. Before meeting with elected officials, make sure that each of the six tasks above has been completed and be able to answer some difficult questions concerning the proposed legislation. Additionally, be ready to demonstrate that there is public support for the legislation; it will be an important factor in convincing an elected official to vote in favor of the legislation. A representative of a large group or coalition will often have more influence than an individual acting alone.

When discussing issues with elected officials, be cordial, factual, and succinct. Most officials have to meet with many people during the course of a day and will appreciate amiable brevity. Cover the major points and be prepared to expound on them when asked. Bring along support material that can be left with the official. This will allow the official, at his or her convenience, to become more familiar with the finer details of the proposed legislation. Lastly, offer to answer any questions the official may have in the future and be sure to leave your name, address, and telephone and fax numbers.

8. MAKE A FORMAL RECOMMENDATION TO ADOPT THE LEGISLATION

A formal recommendation usually involves placing the proposed legislation on the agenda of the commission, board, or council that advises elected officials on new legislation. For example, in Florida, before a lighting ordinance is considered by a county commission, it is usually reviewed by a county planning and zoning board, a development review board, or other appointed board. That board then makes recommendations to the county commission concerning the proposed ordinance. Local government planning and environmental staff should be consulted on how to arrange to place the proposed legislation on the appropriate agenda.

If the legislation must be reviewed by an appointed board (as described above), it would be helpful to arrange personal meetings with board members prior to the public meeting at which the proposed legislation will be considered. In these personal meetings, follow the same guidelines as those for meeting with elected officials.

Prior to the public meeting, contact supporters of the legislation (especially those representing large local organizations) and encourage them to meet with, write to, or call local officials. It is also critical

that they attend the meeting to voice their support. Experts on sea turtle biology and conservation may be particularly well received. Supporters should discuss issues and coordinate their comments before the meeting so that their presentations will not be contradictory and so that different speakers can emphasize different points.

At the public meeting, follow the guidelines for meeting with elected officials (*i.e.*, be prepared, factual, concise, cooperative, cordial, and diplomatic). Also, be aware of and adhere to the proper protocol for public comment. Individual board members should have been provided with background materials and the justification for the proposed legislation; therefore, presentations at the public meeting should be principally a concise review of the main points. Because it is important for board members to be made aware of strong public support for the proposed legislation, supporters should attend in force and many should be prepared to speak. If board members have technical questions about any aspect of the legislation, the individual most qualified to answer the question should do so.

It is of tremendous help to have the support of local environmental and planning staff. Board members will be familiar with staff and will usually place considerable weight on their judgment (hence the importance of working with staff from the beginning).

If controversy over the legislation develops, the board may require one or more public workshops in order to resolve the controversial aspects of the legislation. The legislation then may be given a final review by the board and forwarded to the elected body (*e.g.*, county commission) along with specific recommendations. The process comes to a climax with a vote by the elected body during a public meeting. Because the legislation can be modified at any one of these public workshops or meetings, supporters should participate in each of these steps.

With a concerted effort by supporters, the chances of seeing light-management legislation through to official promulgation are good. Although the arguments for lighting regulations on sea turtle nesting beaches are themselves compelling, a resolute show of public support counts most heavily. The importance of this support cannot be overstated. Even if initial efforts to pass legislation fail, the support fostered during the attempt will convince many to begin addressing the problem themselves and will provide a strong base for future legislative efforts.

9. AFTER THE LEGISLATION IS ADOPTED GET THE WORD OUT

After lighting legislation is adopted, it will be necessary for the local government to send notice of the new legislation to owners of coastal property, informing them of the associated regulations and the time period (often until the next nesting season) during which they must comply. The notice should also inform property owners of the criteria that will be used to determine compliance, the name and address of a contact person within local government, and some general suggestions for bringing lighting into compliance.

CONDUCT LIGHTING INSPECTIONS AND ENFORCE REGULATIONS

For light-management legislation to be effective, comprehensive lighting inspections are needed (see the previous section on lighting inspections). At least one inspection should be made prior to the deadline for compliance stated in the ordinance. Lighting that is not in compliance should be identified so that property owners can be notified in sufficient time to correct the problem. After the deadline for compliance, follow-up lighting inspections should be conducted. Owners of problem lighting identified during the follow-up inspection should be sent a second notice. Reference should be made to the first notice, and a final deadline for compliance should be explicitly stated. Generally, this final deadline would be the end of the aforementioned grace period. Noncompliance beyond the deadline should result in enforcement action (*e.g.*, a fine) unless there are extenuating circumstances.

STAY INVOLVED

After legislation has been adopted and problem lighting has been identified and brought into compliance, it will pay to remain vigilant. As problems with lighting are generally ongoing, so too should be the solution. Vigilance will reduce forgetfulness and apathy and will uncover changes that may make the original legislation less effective, such as amendments that weaken the legislation and discontinuation of lighting inspections or enforcement.

It is important to stay aware of the activities of local government because legislation may be amended at any time; be prepared to address the issues of lighting legislation as they arise. Attending public meetings and preserving contacts with local government staff are key ways to keep abreast of the actions and inactions that may affect light-management efforts.

Literature Cited

- ANONYMOUS. 1983. Guide to High Intensity Discharge Lamps. North American Philips Lighting Corporation, Bloomfield, New Jersey. 23 p.
- ANONYMOUS. 1989. Light Sources, Monochromators, Detection Systems. Oriol Corporation, Stratford, Connecticut. 335 p.
- BROOKE, M. DE L., and M. C. GARNETT. 1983. Survival and reproductive performance of hawksbill turtles *Eretmochelys imbricata* L. on Cousin Island, Seychelles. *Biological Conservation* 25:161–170.
- BURNEY, C. M., C. MATTISON, and L. FISHER. 1991. The relationship of loggerhead nesting patterns and moon phase in Broward County, Florida. Pp. 161–164 in T. H. Richardson, J. I. Richardson, and M. Donnelly, eds. Proceedings of the Tenth Annual Workshop on Sea Turtle Biology and Conservation. NOAA Technical Memorandum NMFS–SEFC–278.
- BUSTARD, H. R. 1967. Mechanism of nocturnal emergence from the nest in green turtle hatchlings. *Nature* 214:317.
- BUSTARD, H. R. 1972. Sea Turtles. Natural History and Conservation. Taplinger, New York. 220 p.
- CALDWELL, M. C., and D. C. CALDWELL. 1962. Factors in the ability of the northeastern Pacific green turtle to orient toward the sea from the land, a possible coordinate in long-range navigation. *Contributions in Science* 60:5–27.
- CARR, A. 1962. Orientation problems in the high seas travel and terrestrial movements of marine turtles. *American Scientist* 50:358–374.
- CARR, A., and L. GIOVANNOLI. 1957. The ecology and migrations of sea turtles. 2. Results of field work in Costa Rica, 1955. *American Museum Novitates* 1835:1–32.
- CARR, A., and H. HIRTH. 1961. Social facilitation in green turtle siblings. *Animal Behaviour* 9:68–70.
- CARR, A., and L. OGREN. 1959. The ecology and migrations of sea turtles. 3. *Dermochelys* in Costa Rica. *American Museum Novitates* 1958:1–29.
- CARR, A., and L. OGREN. 1960. The ecology and migrations of sea turtles. 4. The green turtle in the Caribbean Sea. *Bulletin of the American Museum of Natural History* 121:1–48.
- CARR, A., H. HIRTH, and L. OGREN. 1966. The ecology and migrations of sea turtles. 6. The hawksbill turtle in the Caribbean Sea. *American Museum Novitates* 2248:1–29.
- CHRISTENS, E. 1990. Nest emergence lag in loggerhead sea turtles. *Journal of Herpetology* 24:400–402.
- CHAVEZ, H., M. CONTRERAS G., and T. P. E. HERNANDEZ D. 1968. On the coast of Tamaulipas, part two. *International Turtle and Tortoise Society Journal* 2:16–19, 27–34.
- CORNELIUS, S. E. 1986. The Sea Turtles of Santa Rosa National Park. Fundación de Parques Nacionales, Costa Rica. 64 p.
- COSTON–CLEMENTS, L., and D. E. HOSS. 1983. Synopsis of data on the impact of habitat alteration on sea turtles around the southeastern United States. NOAA Technical Memorandum NMFS–SEFC–117. 57 p.
- DANIEL, R. S., and K. U. SMITH. 1947a. The sea-approach behavior of the neonate loggerhead turtle (*Caretta caretta*). *Journal of Comparative Physiology and Psychology* 40:413–420.
- DANIEL, R. S., and K. U. SMITH. 1947b. The migration of newly-hatched loggerhead turtles toward the sea. *Science* 106:398–399.
- DAWSON, D. W. 1984. Light pollution and its measurement. Pp. 30–53 in R. C. Wolpert, R. M. Genet, and J. Wolpert, eds. *Advances in Photoelectric Photometry*. Vol. 2. Published by the Fairborn Observatory, Patagonia, Arizona.
- DEMME, R. J. 1981. The hatching and emergence of loggerhead turtle (*Caretta caretta*) hatchlings. Unpublished Master's Thesis, University of Central Florida, Orlando. 40 p.
- DICKERSON, D. D., and D. A. NELSON. 1988. Use of long wavelength lights to prevent disorientation of

- hatchling sea turtles. Pp. 19–21 in B. A. Schroeder, ed. Proceedings of the Eighth Annual Workshop on Sea Turtle Biology and Conservation. NOAA Technical Memorandum NMFS–SEFC–214.
- DICKERSON, D. D., and D. A. NELSON. 1989. Recent results on hatchling orientation responses to light wavelengths and intensities. Pp. 41–43 in S. Eckert, K. Eckert, and T. Richardson, eds. Proceedings of the Ninth Annual Workshop on Sea Turtle Conservation and Biology. NOAA Technical Memorandum NMFS–SEFC–232.
- DODD, C. K. 1988. Synopsis of the biological data on the loggerhead sea turtle *Caretta caretta* (Linnaeus 1758). FAO Synopsis NMFS–149, Biological Report 88(14). 110 p.
- EAKIN, J. S. 1986. Tucson tackles sky glow: how one city is helping to protect astronomy. *Light Magazine* 1(2):10–12.
- EHRENFELD, D. W. 1968. The role of vision in the sea-finding orientation of the green turtle (*Chelonia mydas*). II. Orientation mechanism and range of spectral sensitivity. *Animal Behaviour* 16:281–287.
- EHRENFELD, D. W. 1979. Behavior associated with nesting. Pp. 417–434 in M. Harless and H. Morlock, eds. *Turtles: Perspectives and Research*. Wiley and Sons, New York.
- EHRENFELD, D. W., and A. CARR. 1967. The role of vision in the sea-finding orientation of the green turtle (*Chelonia mydas*). *Animal Behaviour* 15:25–36.
- EHRENFELD, D. W., and A. L. KOCH. 1967. Visual accommodation in the green turtle. *Science* 155: 827–828.
- EHRHART, L. M. 1979. Threatened and Endangered Species of the Kennedy Space Center. Part 1. Marine Turtle Studies. Final report to NASA/KSC: A Continuation of Baseline Studies for Environmentally Monitoring STS at JFK Space Center. 301 p.
- FANGMAN, M. S., and K. A. RITTMASER. 1993. Effects of human beach usage on the temporal distribution of loggerhead nesting activities. Pp. 222–227 in B. Schroeder and B. Witherington, eds. Proceedings of the Thirteenth Annual Symposium on Sea Turtle Biology and Conservation. NOAA Technical Memorandum NMFS–SEFC–341.
- FEHRING, W. K. 1972. Hue discrimination in hatchling loggerhead turtles (*Caretta caretta caretta*). *Animal Behaviour* 20:632–636.
- FERREIRA, S. N. M., G. C. M. FILHO, and V. J. PATIRI. 1992. The influence of artificial lighting on the reproduction of sea turtles. Unpublished report from the Eleventh National Seminar of Electrical Power Distribution, Bahia, Brazil. 20 p.
- FERRIS, J. S. 1986. Nest success and the survival and movement of hatchlings of the loggerhead sea turtle (*Caretta caretta*) on Cape Lookout National Seashore. NPS–CPSU Technical Report 19. 40 p.
- FRICK, J. 1976. Orientation and behavior of hatchling green sea turtles (*Chelonia mydas*) in the sea. *Animal Behaviour* 24:849–857.
- GRANDA, A. M., and C. A. DVORAK. 1977. Vision in turtles. Pp. 451–495 in F. Crescitelli, ed. *Handbook of Sensory Physiology*. Vol. VII/5. The Visual System in Vertebrates. Springer-Verlag, Berlin.
- GRANDA, A. M., and K. W. HADEN. 1970. Retinal oil globule counts and distribution in two species of turtles: *Pseudemys scripta elegans* (Wied) and *Chelonia mydas mydas* (Linnaeus). *Vision Research* 10:79–84.
- GRANDA, A. M., and P. J. O'SHEA. 1972. Spectral sensitivity of the green turtle (*Chelonia mydas mydas*) determined by electrical responses to heterochromatic light. *Brain Behavior and Evolution* 5:143–154.
- HAILMAN, J. P., and A. M. ELOWSON. 1992. Ethogram of the nesting female loggerhead (*Caretta caretta*). *Herpetologica* 48:1–30.
- HAYES, W. N., and L. C. IRELAND. 1978. Visually guided behavior of turtles. Pp. 281–317 in D. I. Mostofsky, ed. *The Behavior of Fish and Other Aquatic Organisms*. Academic Press, New York.
- HAYS, G. C., and J. R. SPEAKMAN. 1993. Nest placement by loggerhead turtles, *Caretta caretta*. *Animal Behaviour* 45:47–53.
- HENDRICKSON, J. R. 1958. The green sea turtle, *Chelonia mydas* (Linn.) in Malaya and Sarawak. Proceedings of the Zoological Society of London 130:455–535.
- HIRTH, H. F., and D. A. SAMSON. 1987. Nesting behavior of green turtles (*Chelonia mydas*) at Tor-

- tuguero, Costa Rica. *Caribbean Journal of Science* 23:374–379.
- HOOKE, D. 1907. Preliminary observations on the behavior of some newly hatched loggerhead turtles. *Carnegie Institute Washington Yearbook* 6: 111–112.
- HOOKE, D. 1908a. The breeding habits of the loggerhead turtle and some early instincts of the young. *Science* 27:490–491.
- HOOKE, D. 1908b. Report on the instincts and habits of newly hatched loggerhead turtles. *Carnegie Institute Washington Yearbook* 7:124.
- HOOKE, D. 1911. Certain reactions to color in the young loggerhead turtle. *Papers from the Tortugas Laboratory, Carnegie Institute* 132:71–76.
- IRELAND, L. C., J. A. FRICK, and D. B. WINGATE. 1978. Nighttime orientation of hatchling green turtles (*Chelonia mydas*) in open ocean. Pp. 420–429 in K. Schmidt-Koenig and W. T. Keeton, eds. *Animal Migration, Navigation and Homing*. Springer-Verlag, New York.
- JOHNSON, S. A., K. A. BJORN DAL, and A. B. BOLTEN. 1996. Effects of organized turtle watches on loggerhead (*Caretta caretta*) nesting behavior and hatchling production in Florida. *Conservation Biology* 10:570–577.
- KAUFMAN, J. E., and J. F. CHRISTENSEN (eds.). 1987. Pp. 2–15, 2–16 in *IES Lighting Handbook*. Illuminating Engineering Society of North America, New York.
- LEACH, A. L. 1992. Sea turtle nesting summary report for Cape Canaveral Air Force Station, Florida. 1992. Unpublished report to Johnson Controls World Services Inc., Cape Canaveral Air Force Station, Florida. 19 p.
- LIEBMAN, P. A., and A. M. GRANDA. 1971. Microspectrophotometric measurements of visual pigments in two species of turtle, *Pseudemys scripta* and *Chelonia mydas*. *Vision Research* 11:105–114.
- LIMPUS, C. J. 1971. Sea turtle ocean-finding behaviour. *Search* 2:385–387.
- LIMPUS, C. J. 1991. Marine turtles of Raine Island, Australia. Unpublished paper presented at the Eleventh Annual Workshop on Sea Turtle Biology and Conservation, 26 February–2 March 1991, Jekyll Island, Georgia.
- LIMPUS, C., R. W. CARTER, and S. McLEAN. 1981. Lights and hatchling turtles: an education program. *Marine Turtle Newsletter* 19:11.
- LOHMANN, K. J., M. SALMON, and J. WYNEKEN. 1990. Functional autonomy of land and sea orientation systems in sea turtle hatchlings. *Biological Bulletin* 179:214–218.
- LOHMANN, K. J., B. E. WITHERINGTON, C. M. F. LOHMANN, and M. SALMON. In press. Orientation, navigation, and natal beach homing in sea turtles. In P. L. Lutz and J. A. Musick, eds. *The Biology of Sea Turtles*. CRC Press, Boca Raton, Florida.
- MANN, T. M. 1977. Impact of developed coastline on nesting and hatchling sea turtles in southeastern Florida. Unpublished Master's Thesis, Florida Atlantic University, Boca Raton. 100 p.
- MANN, T. M. 1978. Impact of developed coastline on nesting and hatchling sea turtles in Southeastern Florida. *Florida Marine Research Publications* 33: 53–55.
- MARTIN, R. E., R. G. ERNEST, N. WILLIAMS-WALLS, and J. R. WILCOX. 1989. Long-term trends in sea turtle nesting on Hutchinson Island, Florida. Pp. 111–113 in S. Eckert, K. Eckert, and T. Richardson, eds. *Proceedings of the Ninth Annual Workshop on Sea Turtle Conservation and Biology*. NOAA Technical Memorandum NMFS–SEFC–232.
- MATTISON, C., C. BURNEY, and L. FISHER. 1993. Trends in the spatial distribution of sea turtle activity on an urban beach (1981–1992). Pp. 102–104 in B. Schroeder and B. Witherington, eds. *Proceedings of the Thirteenth Annual Symposium on Sea Turtle Biology and Conservation*. NOAA Technical Memorandum NMFS–SEFC–341.
- McFARLANE, R. W. 1963. Disorientation of loggerhead hatchlings by artificial road lighting. *Copeia* 1963:153.
- MEYLAN, A., B. SCHROEDER, and A. MOSIER. 1995. Sea turtle nesting activity in the State of Florida 1979–1992. *Florida Marine Research Publications* No. 52. 51 p.

- MORTIMER, J. A. 1979. Ascension Island: British jeopardize 45 years of conservation. *Marine Turtle Newsletter* 10:7–8.
- MORTIMER, J. A. 1982. Factors affecting beach selection by nesting sea turtles. Pp. 45–51 in K. A. Bjorndal, ed. *Biology and Conservation of Sea Turtles*. Smithsonian Institution Press, Washington, D.C.
- MROSOVSKY, N. 1970. The influence of the sun's position and elevated cues on the orientation of hatchling sea turtles. *Animal Behaviour* 18:648–651.
- MROSOVSKY, N. 1972. The water-finding ability of sea turtles. *Brain Behavior and Evolution* 5:202–225.
- MROSOVSKY, N. 1977. Individual differences in the sea-finding mechanism of hatchling leatherback turtles. *Brain Behavior and Evolution* 14:261–273.
- MROSOVSKY, N. 1978. Effects of flashing lights on sea-finding behavior of green turtles. *Behavioral Biology* 22:85–91.
- MROSOVSKY, N., and A. CARR. 1967. Preference for light of short wavelengths in hatchling green sea turtles, *Chelonia mydas*, tested on their natural nesting beaches. *Behaviour* 28:217–231.
- MROSOVSKY, N., and S. F. KINGSMILL. 1985. How turtles find the sea. *Zeitschrift fur Tierpsychologie* 67:237–256.
- MROSOVSKY, N., and S. J. SHETTLEWORTH. 1968. Wavelength preferences and brightness cues in the water-finding behaviour of sea turtles. *Behaviour* 32:211–257.
- MROSOVSKY, N., and S. J. SHETTLEWORTH. 1974. Further studies on the sea-finding mechanism in green turtle hatchlings. *Behaviour* 51:195–208.
- MROSOVSKY, N., and S. J. SHETTLEWORTH. 1975. On the orientation circle of the leatherback turtle, *Dermochelys coriacea*. *Animal Behaviour* 23:568–591.
- MROSOVSKY, N., A. M. GRANDA, and T. HAY. 1979. Seaward orientation of hatchling turtles: turning systems in the optic tectum. *Brain Behavior and Evolution* 16:203–221.
- MURPHY, T. 1985. Telemetric monitoring of nesting loggerhead sea turtles subjected to disturbance on the beach. Unpublished paper presented at the Fifth Annual Workshop on Sea Turtle Biology and Conservation, 13–16 February 1985.
- NATIONAL RESEARCH COUNCIL. 1990. *Decline of the Sea Turtles: Causes and Prevention*. National Academy Press, Washington, D.C. 259 p.
- NELSON, D. A. 1992. Night orientation in sea turtles. Pp. 83–86 in M. Salmon and J. Wyneken, eds. *Proceedings of the Eleventh Annual Workshop on Sea Turtle Biology and Conservation*. NOAA Technical Memorandum NMFS–SEFSC–302.
- NEVILLE, A., W. D. WEBSTER, J. F. GOUVEIA, E. L. HENDRICKS, I. HENDRICKS, G. MARVIN, and W. H. MARVIN. 1988. The effects of nest temperature on hatchling emergence in the loggerhead sea turtle (*Caretta caretta*). Pp. 71–73 in B. A. Schroeder, ed. *Proceedings of the Eighth Annual Workshop on Sea Turtle Biology and Conservation*. NOAA Technical Memorandum NMFS–SEFSC–214.
- NORTHMORE, D. P. M., and A. M. GRANDA. 1982. Mechanisms of amphibious accommodation in turtles. *Society for Neuroscience Abstracts* 8:699.
- NORTHMORE, D. P. M., and A. M. GRANDA. 1991. Ocular dimensions and schematic eyes of freshwater and sea turtles. *Visual Neuroscience* 7:627–635.
- O'HARA, J. 1980. Thermal influences on the swimming speed of loggerhead turtle hatchlings. *Copeia* 1980:773–780.
- PARKER, G. H. 1922. The crawling of young loggerhead turtles toward the sea. *Journal of Experimental Zoology* 6:323–331.
- PETERS, A., and K. J. F. VERHOEVEN. 1994. Impact of artificial lighting on the seaward orientation of hatchling loggerhead turtles. *Journal of Herpetology* 28:112–114.
- PHILIBOSIAN, R. 1976. Disorientation of hawksbill turtle hatchlings, *Eretmochelys imbricata*, by stadium lights. *Copeia* 1976:824.
- PRITCHARD, P. C. H., and R. MARQUEZ M. 1973. Kemp's ridley turtle or Atlantic ridley, *Lepidochelys kempii*. IUCN Monograph No. 2. Marine Turtle Series. Morges, Switzerland. 30 p.
- PROFFITT, C. E., R. E. MARTIN, R. G. ERNEST, B. J. GRAUNKE, S. E. LECROY, K. A. MULDOON, B. D.

- PEERY, J. R. WILCOX, and N. WILLIAMS-WALLS. 1986. Effects of power plant construction and operation on the nesting of the loggerhead sea turtle (*Caretta caretta*): 1971-84. *Copeia* 1986:813-816.
- RAYMOND, P. W. 1984a. Sea turtle hatchling disorientation and artificial beachfront lighting. Center for Environmental Education, Washington, D.C. 72 p.
- RAYMOND, P. W. 1984b. The effects of beach restoration on marine turtles nesting in south Brevard County, Florida. Unpublished Master's Thesis, University of Central Florida, Orlando. 112 p.
- REINERS, R., M. SALMON, and C. LAVIN. 1993. Hatchling misorientation on an urban beach (Boca Raton, Florida). P. 146 in B. Schroeder and B. Witherington, eds. Proceedings of the Thirteenth Annual Symposium on Sea Turtle Biology and Conservation. NOAA Technical Memorandum NMFS-SEFC-341.
- ROSSOTTI, H. 1983. *Colour*. Princeton University Press, Princeton, New Jersey. 239 p.
- SALMON, M., and K. J. LOHMANN, 1989. Orientation cues used by hatchling loggerhead sea turtles (*Caretta caretta*, L.) during offshore migration. *Ethology* 83:215-228.
- SALMON, M., and B. E. WITHERINGTON. 1995. Artificial lighting and seafinding by loggerhead hatchlings: Evidence for lunar modulation. *Copeia* 1995:931-938.
- SALMON, M., and J. WYNEKEN. 1987. Orientation and swimming behavior of hatchling loggerhead turtles *Caretta caretta* L. during their offshore migration. *Journal of Experimental Marine Biology and Ecology* 109:137-153.
- SALMON, M., and J. WYNEKEN. 1990. Do swimming loggerhead sea turtles (*Caretta caretta* L.) use light cues for offshore orientation? *Marine Behavior and Physiology* 17:233-246.
- SALMON, M., R. REINERS, C. LAVIN, and J. WYNEKEN. 1995a. Behavior of loggerhead sea turtles on an urban beach. I. Correlates of nest placement. *Journal of Herpetology* 29:560-567.
- SALMON, M., M. G. TOLBERT, D. P. PAINTER, M. GOFF, and R. REINERS. 1995b. Behavior of loggerhead sea turtles on an urban beach. II. Hatchling orientation. *Journal of Herpetology* 29:568-576.
- SALMON, M., J. WYNEKEN, E. FRITZ, and M. LUCAS. 1992. Seafinding by hatchling sea turtles: role of brightness, silhouette and beach slope as orientation cues. *Behaviour* 122:56-77.
- SCHÖNE, H. 1984. *Spatial Orientation*. Princeton University Press, Princeton, N. J. 347 p.
- STONEBURNER, D. L., and J. I. RICHARDSON. 1981. Observations on the role of temperature in loggerhead turtle nest site selection. *Copeia* 1981: 238-241.
- TALBERT, O. R., JR., S. E. STANCYK, J. M. DEAN, and J. M. WILL. 1980. Nesting activity of the loggerhead turtle (*Caretta caretta*) in South Carolina. I. A rookery in transition. *Copeia* 1980:709-719.
- VAN METER, V. B. 1992. *Florida's Sea Turtles*. Florida Power and Light Company. 60 p.
- VAN RHIJN, F. A. 1979. Optic orientation in hatchlings of the sea turtle, *Chelonia mydas*. I. Brightness: not the only optic cue in sea-finding orientation. *Marine Behavior and Physiology* 6:105-121.
- VAN RHIJN, F. A., and J. C. VAN GORKOM. 1983. Optic orientation in hatchlings of the sea turtle, *Chelonia mydas*. III. Sea-finding behaviour: the role of photic and visual orientation in animals walking on the spot under laboratory conditions. *Marine Behavior and Physiology* 9:211-228.
- VERHEIJEN, F. J. 1958. The mechanisms of the trapping effect of artificial light sources upon animals. *Les Archives Neerlandaises de Zoologie* 13:1-107.
- VERHEIJEN, F. J. 1978. Orientation based on directivity, a directional parameter of the animals' radiant environment. Pp. 447-458 in K. Schmidt-Koenig and W. T. Keeton, eds. *Animal Migration, Navigation, and Homing*. Springer-Verlag, Berlin.
- VERHEIJEN, F. J. 1985. Photopollution: artificial light optic spatial control systems fail to cope with. Incidents, causations, remedies. *Experimental Biology* 44:1-18.
- VERHEIJEN, F. J., and J. T. WILDSCHUT. 1973. The photic orientation of sea turtles during water finding behaviour. *Netherlands Journal of Sea Research* 7:53-67.
- WIBBLES, T. R. 1984. Orientation characteristics of

- immature Kemp's ridley sea turtles. NOAA Technical Memorandum NMFS-SEFC-131. 62 p.
- WILLIAMS-WALLS, N., J. O'HARA, R. M. GALLAGHER, D. F. WORTH, B. D. PEERY, and J. R. WILCOX. 1983. Spatial and temporal trends of sea turtle nesting on Hutchinson Island, Florida, 1971-1979. *Bulletin of Marine Science* 33:55-66.
- WITHAM, R. 1982. Disruption of sea turtle habitat with emphasis on human influence. Pp. 519-522 in K. A. Bjorndal, ed. *Biology and Conservation of Sea Turtles*. Smithsonian Institution Press, Washington, D.C.
- WITHERINGTON, B. E. 1986. Human and natural causes of marine turtle clutch and hatchling mortality and their relationship to hatchling production on an important Florida nesting beach. Unpublished Master's Thesis, University of Central Florida, Orlando. 141 p.
- WITHERINGTON, B. E. 1989. Beach lighting and the seaward orientation of hatchling sea turtles. Pp. 189-190 in S. Eckert, K. Eckert, and T. Richardson, eds. *Proceedings of the Ninth Annual Workshop on Sea Turtle Conservation and Biology*. NOAA Technical Memorandum NMFS-SEFC-232.
- WITHERINGTON, B. E. 1990. Photopollution on sea turtle nesting beaches: problems and next-best solutions. Pp. 43-45 in T. H. Richardson, J. I. Richardson, and M. Donnelly, eds. *Proceedings of the Tenth Annual Workshop on Sea Turtle Biology and Conservation*. NOAA Technical Memorandum NMFS-SEFC-278.
- WITHERINGTON, B. E. 1991. Orientation of hatchling loggerhead turtles at sea off artificially lighted and dark beaches. *Journal of Experimental Marine Biology and Ecology* 149:1-11.
- WITHERINGTON, B. E. 1992a. Behavioral responses of nesting sea turtles to artificial lighting. *Herpetologica* 48:31-39.
- WITHERINGTON, B. E. 1992b. Sea-finding behavior and the use of photic orientation cues by hatchling sea turtles. Ph.D. Dissertation, University of Florida, Gainesville. UMI Dissertation Information Service, Ann Arbor. 241 p.
- WITHERINGTON, B. E. 1992c. How are hatchling sea turtles able, and unable, to locate the sea? Pp. 127-130 in M. Salmon and J. Wyneken, eds. *Proceedings of the Eleventh Annual Workshop on Sea Turtle Biology and Conservation*. NOAA Technical Memorandum NMFS-SEFSC-302.
- WITHERINGTON, B. E. In press. The problem of photopollution for sea turtles and other nocturnal animals. In J. R. Clemmons and R. Buchholz, eds. *Behavioral Approaches to Conservation in the Wild*. Cambridge University Press, Cambridge, England.
- WITHERINGTON, B. E., and K. A. BJORNDAL. 1991a. Influences of wavelength and intensity on hatchling sea turtle phototaxis: implications for sea-finding behavior. *Copeia* 1991:1060-1069.
- WITHERINGTON, B. E., and K. A. BJORNDAL. 1991b. Influences of artificial lighting on the seaward orientation of hatchling loggerhead turtles (*Caretta caretta*). *Biological Conservation* 55:139-149.
- WITHERINGTON, B. E., and M. SALMON. 1992. Predation on loggerhead turtle hatchlings after entering the sea. *Journal of Herpetology* 26:226-228.
- WITHERINGTON, B. E., C. CRADY, and L. BOLEN. 1996. A "hatchling orientation index" for assessing orientation disruption from artificial lighting. Pp. 344-347 in J. A. Keinath, D. E. Barnard, J. A. Musick, and B. A. Bell, eds. *Proceedings of the Fifteenth Annual Symposium on Sea Turtle Biology and Conservation*. NOAA Technical Memorandum NMFS-SEFSC-387.
- WITHERINGTON, B. E., K. A. BJORNDAL, and C. M. McCABE. 1990. Temporal pattern of nocturnal emergence of loggerhead turtle hatchlings from natural nests. *Copeia* 1990:1165-1168.
- WITZELL, W. N., and A. C. BANNER. 1980. The hawksbill turtle (*Eretmochelys imbricata*) in Western Samoa. *Bulletin of Marine Science* 30:571-579.
- WORTH, D. F., and J. B. SMITH. 1976. Marine turtle nesting on Hutchinson Island, Florida, in 1973. *Florida Marine Research Publication* 18:1-17.
- WYNEKEN, J., M. SALMON and K. J. LOHMANN. 1990. Orientation by hatchling loggerhead sea turtles *Caretta caretta* L. in a wave tank. *Journal of Experimental Marine Biology and Ecology* 139:43-50.

APPENDICES

APPENDIX A

The following is a list of artificial light sources grouped by the level of disruption they are likely to cause sea turtles. The criteria used to group the sources came from studies of physiological spectral sensitivity (Granda and O'Shea, 1972), hatchling orientation with respect to laboratory light sources (Mrosovsky and Carr, 1967; Mrosovsky and Shettleworth, 1968; Mrosovsky, 1972; Witherington and Bjorndal, 1991a; Witherington, 1992b) and commercial light sources (Dickerson and Nelson, 1988, 1989; Witherington, 1989; Witherington and Bjorndal, 1991b; Ferreira *et al.*, 1992; Nelson, 1992; Witherington, 1992b), and spectral profiles of commonly used lamps (Anonymous, 1983; Rossotti, 1983; Anonymous, 1989; Witherington and Bjorndal, 1991b). Effects are described as being extremely disruptive, highly disruptive, moderately disruptive, or minimally disruptive.

White, broad-spectrum, short-arc lighting (*extremely disruptive*).—These light sources include xenon and mercury arc lamps and are the brightest and highest-energy light sources commonly used. They emit wavelengths rather evenly across the visible spectrum (which is why they appear white) and in the ultraviolet spectrum as well. They are used principally for temporary, intense lighting needs.

White, broad-spectrum, electric-discharge lighting (*extremely disruptive*).—Mercury-vapor, metal-halide, and fluorescent-tube lighting are included in this group. Like sources in the preceding group, these sources emit wavelengths across the visible spectrum. They are used both indoors and outdoors. Fluorescent-tube lighting is becoming more common as an indoor source and is frequently used to light porches and outdoor signs.

Color-phosphor and tinted-fluorescent lighting (“blacklight” ultraviolet, violet, blue, green, and mixtures of these colors) (*extremely disruptive*).—As revealed to some extent by their colors, these electric-discharge tube lamps emit light principally in the short-wavelength end of the visible spectrum. The so-called “blacklight”-type fluorescent tubes, however, emit much of their light in the near-ultraviolet region. These blacklight tubes appear as a dim violet color to humans but are very disruptive to sea turtle hatchlings. Blacklights are often used as insect attractants in insect-electrocuting “bug-zappers.” Tubes of other colors are principally used for decorative applications.

White, broad-spectrum, incandescent lighting (*extremely disruptive*).—Light emitted from incandescent sources comes from a glowing filament. This group includes quartz-tungsten-halogen and simple tungsten-filament sources. Without tinting, these sources emit wavelengths throughout the visible spectrum but less so in the short-wavelength end of the spectrum than the sources described above. Incandescent sources are commonly used as outdoor

floodlights, as indoor lighting (*i.e.*, the common light bulb), and as transient lighting (flashlights, lanterns, and electric torches).

Color-tinted incandescent lighting (blue and green) (*extremely disruptive*).—These colored sources are tinted so that they emit principally short-wavelength light; they are often used in decorative applications.

White, pressurized-fuel, glowing-element lanterns (*extremely disruptive*).—These portable lanterns are used for camping, fishing, and other transient nighttime activities.

High-pressure sodium vapor (HPS) lighting (*highly disruptive*).—HPS sources emit light with minor wavelength peaks in the blue and green regions and major peaks in the yellow and orange regions of the visible spectrum. The color of HPS sources is whitish golden to peach. Although less disruptive than the broad-spectrum white sources above, HPS is one of the most commonly used outdoor light sources in the USA and many other countries and is one of the most common causes of hatchling misorientation and mortality.

Open fires (*moderately to highly disruptive*).—Although fires are temporary light sources and emit less short-wavelength light than the sources above, they have been documented as a significant source of hatchling mortality. Unlike other attractive light sources, fires can kill hatchlings quickly (hatchlings are known to crawl into fires and die). The size and temperature of a fire determines how attractive it is to hatchlings.

Yellow-phosphor and amber-tinted fluorescent lighting and red tubes (*moderately disruptive*).—Yellow and amber fluorescent tubes emit principally red, yellow, and green wavelengths but do not exclude light in the blue region of the spectrum as well as yellow incandescent bulbs do. Yellow and amber fluorescent tubes are not generally marketed as “bug lights.” Although they are more disrupt-

tive to sea turtles than yellow incandescent bulbs, yellow and amber fluorescents are far better than white or other colored tubes for use near nesting beaches. However, the hue of these yellow fluorescent lamps varies between manufacturers and can have a varied effect on sea-finding in hatchlings. Red tubes are typically used for decoration and can be of two types: red (or reddish), phosphor-fluorescent tubes and red, neon tubes. Reddish or red-purple fluorescent tubes can be very disruptive, depending upon the amount of short-wavelength light that they emit (purplish lights emit both blue and red light). Neon tubes are covered below.

Lamps with yellow or orange dichroic long-pass filters (*minimally to moderately disruptive*).—Because these filters are very good at attenuating short wavelengths, the type of lamp used with them matters little. Consequently, these filters may allow the use of lamps like metal-halide and HPS that have small and easily focused elements. These lamps can be used in more directional fixtures in order to reduce stray light. Dichroic filters are not standard off-the-shelf accessories for commercial fixtures but they have been used in some outdoor applications near nesting beaches.

Color-tinted incandescent lighting (yellow and red) (*minimally to moderately disruptive*).—Yellow or amber incandescent light bulbs (bug lights) are generally only weakly attractive to hatchlings for the same reason that they attract few insects — they emit little short-wavelength light. Although they are minimally disruptive for the most part, bug lights can interfere with sea-finding if they are numerous, of high wattage, or close to the nesting beach. Red-tinted incandescent sources are more variable in color than bug lights. Some red sources can turn purple or pinkish over time (an indication of greater short-wavelength emission) and become more attractive to hatchlings.

Low-pressure sodium vapor (LPS) lighting (*minimally disruptive*).—LPS is by far the least disruptive light source among those commonly used. LPS sources emit a light that is pure (monochromatic) yellow, a region of the spectrum that is only weakly attractive or even aversive (at higher intensities for loggerheads only) to orienting hatchlings. Because

LPS sources have poor color rendition, they are used principally for outdoor applications.

Red light-emitting diode (LED) lighting (*minimally disruptive*).—LEDs are miniature lamps that are not commonly used outdoors. In the future, LEDs may be used to a greater extent as sign lighting and pathway lighting. Red LEDs come close to being ideal for use near sea turtle nesting beaches. Red LEDs emit a pure-red light that does not vary in color over the life of the lamp, and because they are small, they light only a limited area. They are easy to hide from the beach and have a very long life. Green and amber LEDs are marketed but are much less preferred than red.

Neon tubes (*minimally disruptive*).—True neon tubes (not tinted tubes) are a pure-red light source. At present, neon is used almost exclusively for decorative purposes. Neon tubes can be difficult to shield, but their color makes them minimally disruptive. Potential applications include pathway and ground-level lighting.

Transient light sources (flashlights, electric torches, flash photography) (*disruptive characteristics vary*).—This lighting is placed in a separate category because it is generally in use for relatively short time periods. Most of these sources have white incandescent lamps and can be expected to affect sea turtles as the incandescent sources above do. Transient sources are well-known disruptors of sea-finding behavior in hatchlings and adults, but researchers are less certain about how transient sources may affect nesting turtles or those emerging from the ocean to nest. Many workers in the field believe that flashlights and flashes from cameras can turn emerging turtles back to the sea and alter the behavior of nesting turtles. Until additional evidence suggests otherwise, transient light sources should be used sparingly on sea turtle nesting beaches. If hand-held lighting is to be used, deep-red filters should be fastened over the lens of the source. Red light appears much brighter to humans than it does to sea turtles and does not degrade the night vision of people using it. People using red light are able to acclimate to the dark, and most are surprised by how well they can see by starlight and moonlight alone.

APPENDIX B

A table of lamp types and their efficiency. Information sources were the lighting manufacturers and distributors listed in Appendix G. General suitability is based upon the lamp characteristics that may affect sea turtle nesting and hatchling orientation.

Lamp Type	General Suitability for Sea Turtle Nesting Beaches	Efficiency (lumens per watt, lamp only)	Common Wattages	Directional Control of Light	Initial Fixture Cost
White incandescent (including tungsten halogen)	poor	15–25	15–1,500	excellent	low
White fluorescent	poor	55–100	9–219	fair	moderate
Metal-halide	poor	80–100	70–1,000	good	high
Mercury-vapor	poor	20–60	40–1,000	good	moderate–high
High-pressure sodium vapor	poor–fair	67–140	35–1,000	good	high
Low-pressure sodium vapor	good	180	18–180	fair	high

APPENDIX C

The following table describes the generally available incandescent lamps (yellow, bug-light bulbs) that can be suitable for use near nesting beaches if employed properly. Lighted lamps are properly employed if they are not visible from the beach. These bulbs can be used in place of white light bulbs in incandescent fixtures (e.g., porch, balcony, doorway, walkway, stairway, and security lighting) and can be used in conjunction with motion-detector fixtures.

Manufacturer	Trade Name	Lamp Wattage
General Electric Lighting	40 A/Y Bug Lite	40
"	60 A/Y Bug Lite	60
"	100 A/Y Bug Lite	100
"	85 PAR/FL/BG Outdoor Floodlight	85
Osram Sylvania	15 A/Y	15
"	25 A/Y	25
"	40 A/Y	40
"	60 A/Y Bug Lite	60
"	100 A/Y Yellow Bug Lite	100
"	100 PAR/EL/Y/RP Yellow Flood	100
"	150 A/Y Yellow Bug Lite	150

Remarks: Other amber or yellow incandescent bulbs and floodlights are available from various manufacturers and are expected to be much better than comparable white incandescent lamps for applications near nesting beaches. However, yellow or amber color alone does not ensure that the lamp will, like true buglights, only moderately disrupt hatchling orientation. Amber-tinted, compact-fluorescent tubes are also sold and are far better than white fluorescent tubes but are not as acceptable as incandescent bug lights. *JANMAR Lighting* (Appendix G) offers 5-, 7-, 9-, and 13-watt (PL-5, PL-7, PL-9, and PL-13), amber-tinted compact-fluorescent tubes.

APPENDIX D

The following tables describe common styles of light fixtures that may be suitable for use near sea turtle nesting beaches if they are employed properly. Fixtures are properly employed if their light is neither directly nor indirectly visible from the beach. Other fixtures are listed here as conditionally acceptable for use near nesting beaches because they contain low-pressure sodium lamps. These light sources should be positioned so that their light is not directly visible from the beach. In all cases, LPS fixtures are greatly preferred to comparable incandescent or HID (high-intensity discharge) fixtures. Abbreviations are as follows: HPS = high-pressure sodium vapor, LPS = low-pressure sodium vapor, MV = mercury vapor, MH = metal halide, Incan. = incandescent, Fluor. = fluorescent.

Low-Profile Luminaires, Tier Lights

Used for safety along walkways and around pools and decks.

Manufacturer	Trade Name	Lamp Type	Lamp Wattage
Intermatic, Inc.	Malibu Tier Lights	Low-voltage incandescent	11
"	Malibu Tier II Lights	"	7
"	Malibu Tier Deck Lights	"	7, 11
"	Malibu Dimension Prismatic	"	11
"	Malibu Shaded Tier Lights	"	11
"	Malibu Metal Tier Lights	"	11
"	Malibu Walklights	"	11
"	Malibu Mushroom Lights	"	11

Remarks: Tier lights are preferable to globe lights, pole-mounted lighting, or floodlights for applications near the crest of the dune or on the seaward side of buildings. However, the fixture should be positioned so that vegetation, topography, or buildings screen the light from the beach, or the fixture should be equipped with shields so that light sources are not visible from the beach. Optional timers are available for the models listed above.

Low-Profile Luminaires, Bollard Lights

Used for safety along walkways and around pools and decks. Also suitable for parking areas.

Manufacturer	Trade Name	Lamp Type	Lamp Wattage
Lithonia Lighting	KBS6 (6" square bollard) ¹	incandescent	116 max.
"	KBS8 (8" square bollard) ¹	"	150 max.
"	KBR6 (6" round bollard) ¹	"	116 max.
"	KBR8 (8" round bollard) ¹	"	150 max.
Quality Lighting	Design 310 (16" bollard)	HPS ²	150
"		MH and MV ²	175
"	Design HB Post-mounted Luminaire	LPS	18 and 35
"	Design HBB Bollard	LPS	18
Spaulding Lighting	Fresno I LPS (square bollard) ³	LPS	18 and 35
"	Fresno II LPS (round bollard) ³	LPS	18 and 35
Sterner Lighting Systems	Softform Bayshore	incandescent	100 max.
"	Annapolis (square bollard)	"	150 max.
"		MV, MH, and HPS ²	175 max.
"	Annapolis (round bollard)	incandescent	150 max.
"		MV, MH, and HPS ²	175 max.

Remarks: See remarks for tier lighting. Many of the lamp wattages given here are maximum values for the fixture; the lowest-wattage lamp (and corresponding ballast) needed for a specific application should be used. Incandescent bug-light lamps and LPS are the most suitable for use near nesting beaches.

¹Half shields are available for Lithonia bollards.

²HID lamps (HPS, MV, MH) are not recommended for use close to nesting beaches because of the color and high light output of these lamps. LPS and incandescent bug-light lamps are good substitutes.

³Spaulding bollards should be used with optional internal louvers that provide a 90° light cutoff (a complete blocking of lateral light).

Low-Profile Luminaires, Miscellaneous Low-Level Lighting

Used for safety along walkways, around pools and decks, and in parking areas.
Rail lighting and tivolli lighting are used for lighting stairways, steps, and handrails.

Manufacturer	Trade Name	Lamp Type	Lamp Wattage
Sterner Lighting Systems	Quantico	incandescent MH and HPS	150 max. 175 max.
"	Softform Illuminated Rail ¹	fluor. and incan.	varies
Lithonia Lighting	Recessed Step Light ELA VSL H1212 ²	Low-volt. incan.	12
Starfire Lighting	Startube Linear Lighting ³	Low-volt. incan.	0.5
ERS, Inc.	Single-faced LED Strip Lighting ⁴	Red LED	2 W per light strip
Hydrel	9600 Recessed Wall Lights with Filter ⁵	MH and HPS	100

Remarks: See remarks for tier and bollard lighting.

¹This lighting, which is hidden within handrails, is greatly preferred over elevated lighting for illuminating stairways and walkways. Where possible, incandescent bug-light lamps or amber-tinted fluorescent tubes should be used.

²This louvered lighting is recessed at foot- to waist-level within walls and is greatly preferred over elevated lighting for illuminating stairways and walkways.

³Linear lighting comes encased in plastic strips and is also sold under the trade names Tivoli, Xanadu, Track-tube, Tubelite, and Step Lite. Yellow tubes can be used with this lighting to further reduce effects on sea turtles. Linear lighting mounted at foot-level along walking paths or stairways is greatly preferred over elevated lighting.

⁴A very good light source for beach steps and walkovers. This lighting can be customized for many applications. Red LEDs (light-emitting diodes) should be specified.

⁵This fixture can be equipped with a yellow, dichroic, band-pass filter. This application has been used by *Specified Lighting* (Appendix G).

Wall- and Ceiling-Mounted Downlighting

Used for safety and security along walkways, near doorways, on balconies and porches, and along stairways.

Manufacturer	Trade Name	Lamp Type	Lamp Wattage
Lithonia Lighting	Gotham Incandescent C Series Downlighting (includes wall-, ceiling-, and pendant-mounted cylinders and cuboids)	incandescent	50–300
Voigt Lighting	Pragmatic Universal Indoor/Outdoor Downlights	incandescent LPS	40–60 35

Remarks: Matte-black nonreflective baffles are recommended. For high-elevation applications (*e.g.*, upper-story balconies) or applications near the beach, low-wattage bug-light lamps or LPS lamps are recommended.

Recessed, Ceiling Downlighting

Used for safety and security in place of floodlighting and globe lights. These fixtures are recessed into the soffit (positioned under eaves) or into porch and balcony ceilings.

Manufacturer	Trade Name	Lamp Type	Lamp Wattage
Lithonia Lighting	Advantage Incandescent LPJ and LP Frame-in Modules	incandescent	75–150
"	Advantage Incandescent LICJ, LICJ, and LICM Housings	incandescent	40–100
"	Gotham Incandescent: A, D, E, and R Series with black baffles	incandescent	100–200

Remarks: See remarks for wall- and ceiling-mounted downlighting.

Arm-Mounted and Pole-Top HID Cutoff Luminaires

Used for safety and security at parking areas, roadways, and other outdoor areas.

Manufacturer	Trade Name	Lamp Type	Lamp Wattage	
Lithonia Lighting	KSF: Arm-mounted Premium Cutoff, HID	HPS	70–1,000	
		MH	100–1,000	
		MV	100–1,000	
	"	KVS: Arm-mounted Square Cutoff, HID	HPS	150–1,000
			MH	175–1,000
	"	KAS: Arm-mounted Rectilinear Cutoff, HID	HPS	70–1,000
			MH	100–1,000
	"	KQS: Square Post-top Cutoff, HID	HPS, MH, MV	250–1,000
	"	KKS: Square Post-top Cutoff HID	HPS	70–400
			MH	175–400
Quality Lighting	Design SND Arm-mounted Luminaire	HPS	400	
		MH	400	
	"	Design SJ Sharp-cutoff Arm-mounted Rectilinear Luminaire	HPS	150–1,000
			MH	250–1,000
"	Design SNDY Post-top	HPS, MH	400	
Stern Lighting	Executive 20, 25, and 30	incandescent, HPS, MH	1,000 max.	
	Diplomat 20 and 25 (pole-top)	incandescent, HPS, MH	400 max.	
	LeBox (pole-top or wall-mount)	HPS, MH	1,000 max.	

Remarks: These HID fixtures are not recommended for applications within 50 meters of a nesting beach or where luminaires are visible from a nesting beach. However, these cutoff luminaires are preferred to less directional luminaires (*e.g.*, globe-style, cube-style, and cobra-head lighting). The luminaires listed here have optional shields that can further reduce the light reaching the beach. Specific reflectors can also be used with each fixture to better direct light. Arm-mounted LPS fixtures are greatly preferred over HID fixtures for the same applications.

Arm-Mounted and Pole-Top LPS Cutoff Luminaires

Used for safety and security at parking areas, roadways, and other outdoor areas.

Manufacturer	Trade Name	Lamp Type	Lamp Wattage
Voigt Lighting	Slimliner LPS ¹	LPS	35, 55, 90, 135, 180
"	Wideliner LPS	LPS	35, 55, 90, 135
"	SEPOL (Sea turtle Environment Protective Outdoor Luminaire) ¹	LPS	18, 35, 55, 90, 135
Lithonia Lighting	KT: Arm-mounted Cutoff, LPS	LPS	90
Spaulding Lighting	Palomar LPS	LPS	35, 55, 90, 135, 180
"	Oakland LPS	LPS	35, 55, 90, 135, 180
"	Berkeley LPS	LPS	35, 55, 90, 135, 180
"	Phoenix LPS	LPS	35, 55, 90, 135, 180
"	Sunnyvale LPS	LPS	90, 135, 180
Quality Lighting	SM Series Arm-mounted Cutoff LPS	LPS	35, 55, 90, 135, 180
"	Designs SS/SE Rectilinear LPS	LPS	55, 90, 135, 180
Thomas Industries	Form Ten/LPS Rectilinear		
Gardco Lighting	Sharp Cutoff Luminaire ²	LPS	90, 135, 180
Sterner Lighting	Softform Pacific LPS	LPS	90, 135
Solar Outdoor Lighting	Solar LPS ²	LPS	18, 35,
C-Ran Corp.	Anytime Lighting, LPS ²	LPS	18, 35

Remarks: These cutoff luminaires are preferred to less directional luminaires (*e.g.*, globe-style, cube-style, and cobra-head fixtures). Optional shields on some fixtures can further reduce the light reaching the beach. Specific reflectors can also be used with each fixture to better direct their light. Arm-mounted LPS fixtures are greatly preferred over HID fixtures for the same applications.

¹Optional shields are available for these fixtures.

²These luminaires are powered by solar panels for use at remote locations.

LPS Ceiling-Mounted Fixtures

Used for safety and security at parking garages and large doorway and stairway areas.

Manufacturer	Trade Name	Lamp Type	Lamp Wattage
Voigt Lighting	Slimliner LPS ¹	LPS	35, 55, 90, 135, 180
"	Under-decker LPS	LPS	35, 55, 90, 135, 180
"	SEPOL (Sea turtle Environment Protective Outdoor Luminaire) ¹	LPS	18, 35, 55, 90, 135
"	Indoor/Outdoor Frugalume II	LPS	35, 55
Spaulding Lighting	Troy LPS Ceiling Mount Luminaire	LPS	18, 35, 55, 90, 135, 180
Thomas Industries, Benjamin Division	New Horizon/OLH Ceiling Mount Luminaire	LPS	35
"	Intensifier/IVP Ceiling Mount Luminaire	LPS	35, 55, 90, 135, 180

Remarks: Ceiling-mounted luminaires on upper stories facing the beach should be shielded or positioned so that their light is not visible from the beach.

¹Optional shields are available for these fixtures.

LPS Wall-Mounted Fixtures

Used for safety and security at parking garages, walkways, and large doorway and stairway areas.

Manufacturer	Trade Name	Lamp Type	Lamp Wattage
Lithonia Lighting	KTW: Wall Pak, LPS with Full Shield	LPS	90
"	TWH: Glass Refractor Wall Pak	LPS	35
Quality Lighting	Design NW-II: Aluminum Wall Pak	LPS	18
"	Design NW-IV: Aluminum Wall Pak	LPS	90, 135, 180
Spaulding Lighting	Mesa LPS Wall Pack	LPS	35, 55, 90
"	Phoenix LPS Luminaire, PWM	LPS	35, 55, 90, 135, 180
"	Scottsdale LPS Wall Mount	LPS	35, 55
Thomas Industries, Benjamin Division	LEO, OLB, and OLW Luminaires	LPS	18
"	OWP Wall Mount LPS	LPS	35, 55
Voigt Lighting	Pragmatic Universal Downlight	LPS	35
"	Little Protector Wall Mount	LPS	10, 18
"	Midas Touch Wall Mount ¹	LPS	18

Remarks: The light from these wall-mounted fixtures is typically poorly directed, but these fixtures are highly recommended when their light will not be directly visible from the beach. Small 10- and 18-watt LPS fixtures are greatly preferred to incandescent and HID luminaires for porches, balconies, and doorways on the beach side of buildings.

¹Has an optional internal shield.

Floodlighting Fixtures, LPS and HID

Used for safety and security at large walkways, parking lots, road intersections, and other expansive areas.

Manufacturer	Trade Name	Lamp Type	Lamp Wattage
Voigt Lighting	Wall-Most LPS Flood ¹	LPS	35, 55, 90, 135, 180
Sterner Lighting	Model 871, 872, 875, and 876 Area Lighting	HPS	250, 400, 1,000

Remarks: Floodlighting can be directed well. Floodlighting is properly directed if it faces away from the beach and is mounted at an elevated position facing downward rather than mounted low and facing upward. LPS fixtures are greatly preferred over HID fixtures for applications near nesting beaches. In all cases, care should be taken not to brightly illuminate buildings and other large objects visible from the nesting beach.

¹This fixture has an optional internal uplight shield.

Motion-Detector Lighting

Used for safety and security at walkways, yards, doorways, stairways, and storage areas.

Manufacturer	Trade Name	Lamp Type	Lamp Wattage
Heath Zenith	Reflex Professional Motion Sensor Model SL 5314	incandescent	15-300
Intelectron	Motion Detector Conversion Kit Model BC 8950	incandescent	15-300
"	Motion Detector Security Light Model BC 8700 KW	incandescent	15-300

Remarks: Motion-detector lighting fixtures switch on when approached by moving objects and remain on for a specified time, which can be set at the fixture. This specified time should be 30 seconds or less for fixtures near nesting beaches. To reduce impacts to sea turtles to the greatest extent, yellow bug-light bulbs should be used with these fixtures. If floodlights are used, they should be directed away from the nesting beach.

APPENDIX E

Diagrams of common lighting fixtures showing mounting position, light distribution, and overall suitability for use near sea turtle nesting beaches. For purposes of recommending suitable mounting distances from nesting beaches, the crest of the primary dune is considered to be the landward limit of the beach. Fixtures are assessed for their suitability in minimizing direct and indirect lighting of the beach. For all fixtures, glowing portions of luminaires (including reflectors and globes) should not be visible from the nesting beach.

WALL-MOUNTED AREA LIGHTING

MOUNTING SUITABILITY:

Poor. Very poor when mounted on upper stories.

DIRECTIONAL SUITABILITY:

Poor.

OVERALL SUITABILITY:

Poor. Not suitable for the beach sides of buildings.

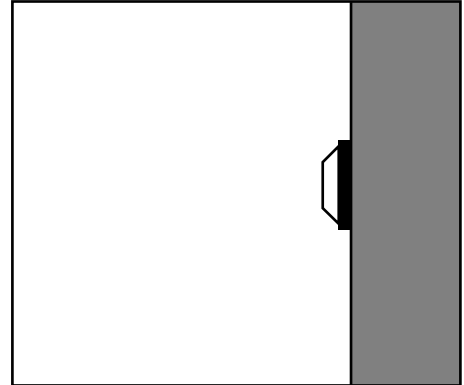

WALL-MOUNTED AREA LIGHTING, "WALL PAK"

MOUNTING SUITABILITY:

Poor. Very poor when mounted on upper stories.

DIRECTIONAL SUITABILITY:

Poor.

OVERALL SUITABILITY:

Poor. Not suitable for the beach sides of buildings.

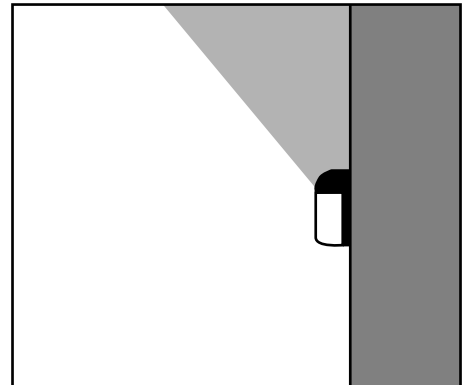

DECORATIVE CUBE LIGHT

MOUNTING SUITABILITY:

Fair if mounted at heights lower than 2 m. Poor if mounted higher.

DIRECTIONAL SUITABILITY:

Very poor.

OVERALL SUITABILITY:

Very poor. This fixture is difficult to shield and should not be used near nesting beaches.

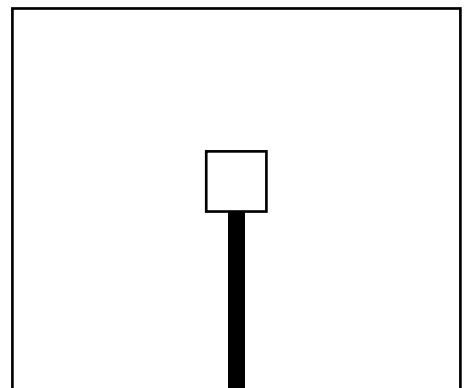

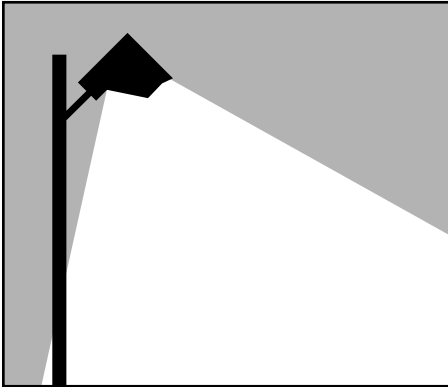

POLE-MOUNTED FLOODLIGHTING WITH FULL VISOR

MOUNTING SUITABILITY:

Good if directed downward and away from the beach.

DIRECTIONAL SUITABILITY:

Good.

OVERALL SUITABILITY:

Good if directed downward and away from the nesting beach and if light does not illuminate objects visible from the beach.

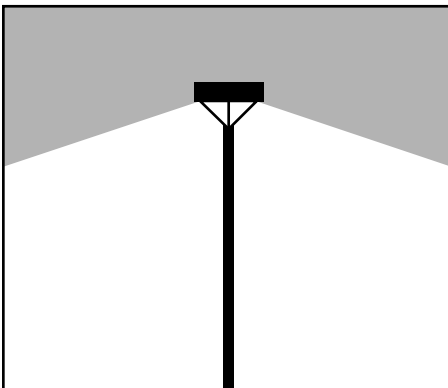

POLE-TOP-MOUNTED CUTOFF LIGHTING, "SHOEBOX" FIXTURE

MOUNTING SUITABILITY:

Good to poor, depending on mounting height. Mounting height should be no more than 5 m within 100 m of a nesting beach.

DIRECTIONAL SUITABILITY:

Fair to good, as determined by reflectors.

OVERALL SUITABILITY:

Fair to good when mounting heights are low.

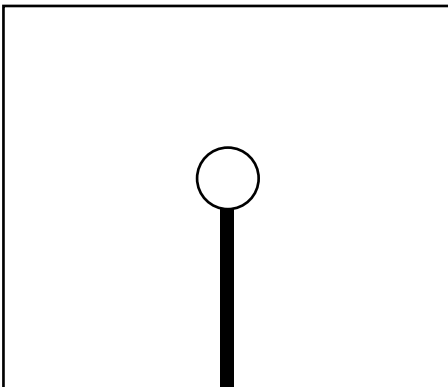

DECORATIVE GLOBE LIGHT

MOUNTING SUITABILITY:

Fair if mounted at heights lower than 2 m. Poor if mounted higher.

DIRECTIONAL SUITABILITY:

Very poor.

OVERALL SUITABILITY:

Very poor. This fixture is difficult to shield and should not be used near nesting beaches.

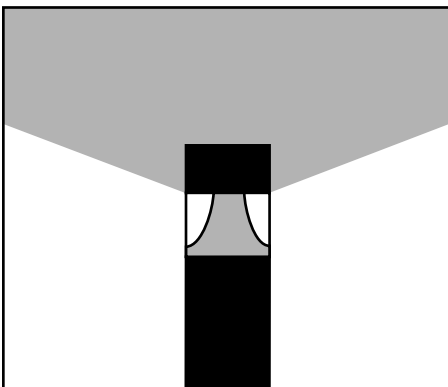

LIGHTING BOLLARD WITH HIDDEN LAMP

MOUNTING SUITABILITY:

Good if mounting height is near 1 m.

DIRECTIONAL SUITABILITY:

Poor to fair.

OVERALL SUITABILITY:

Fair. Good if additional shields on the beach side of the fixture are used.

LOW-LEVEL “MUSHROOM” LIGHTING

MOUNTING SUITABILITY:

Good if mounted at foot level.

DIRECTIONAL SUITABILITY:

Poor.

OVERALL SUITABILITY:

Fair. Good to excellent if used so that vegetation and topography block its light from the beach.

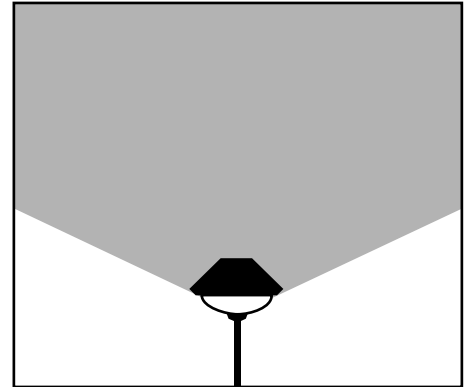

LOW-LEVEL “TIER” LIGHTING

MOUNTING SUITABILITY:

Good if mounted at foot level.

DIRECTIONAL SUITABILITY:

Poor but can be good if the fixture has louvers that eliminate lateral light.

OVERALL SUITABILITY:

Fair. Good to excellent if used so that vegetation and topography block its light from the beach.

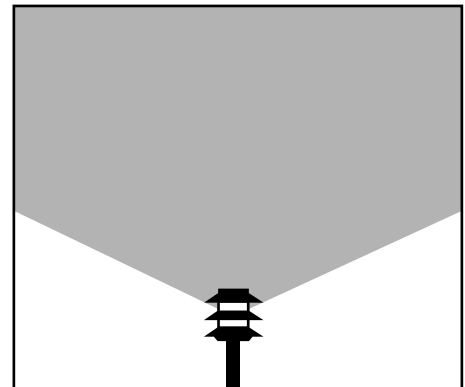

LIGHTING BOLLARD WITH LOUVERS

MOUNTING SUITABILITY:

Good if mounting height is near 1 m.

DIRECTIONAL SUITABILITY:

Good.

OVERALL SUITABILITY:

Good.

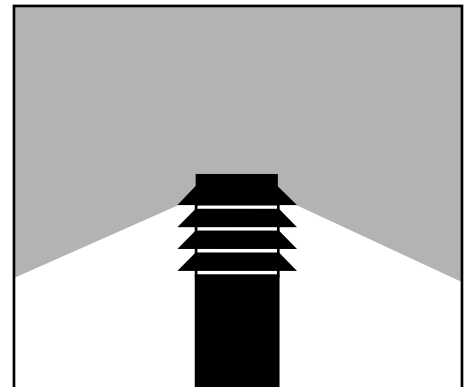

GROUND-MOUNTED FLOODLIGHTING

MOUNTING SUITABILITY:

Poor, because of its upward aim.

DIRECTIONAL SUITABILITY:

Fair to good.

OVERALL SUITABILITY:

Fair to poor if directed away from the beach. Very poor if directed toward the beach.

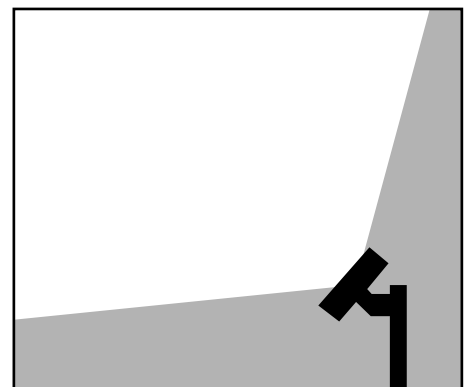

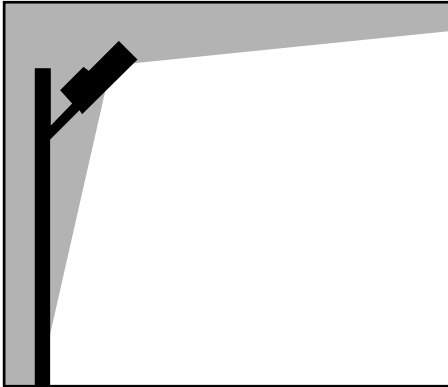

POLE-MOUNTED FLOODLIGHTING

MOUNTING SUITABILITY:

Fair if directed downward and away from the beach.

DIRECTIONAL SUITABILITY:

Fair to good.

OVERALL SUITABILITY:

Fair to good if aimed downward and directly away from the nesting beach and if light does not illuminate objects visible from the beach. Otherwise, poor to very poor.

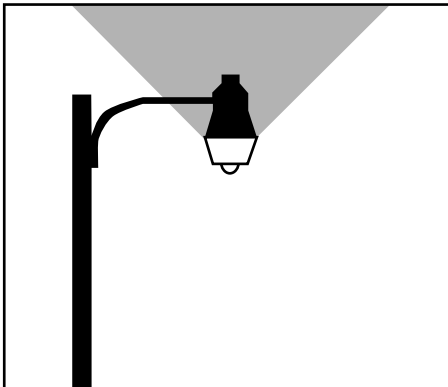

ARM-MOUNTED AREA LIGHTING, "OPEN-BOTTOM" OR "BARN LIGHT" FIXTURE

MOUNTING SUITABILITY:

Poor to very poor, depending upon mounting height. Should not be mounted higher than 5 m within 150 m of a nesting beach.

DIRECTIONAL SUITABILITY:

Poor if unshielded. Fair if shielded.

OVERALL SUITABILITY:

Poor.

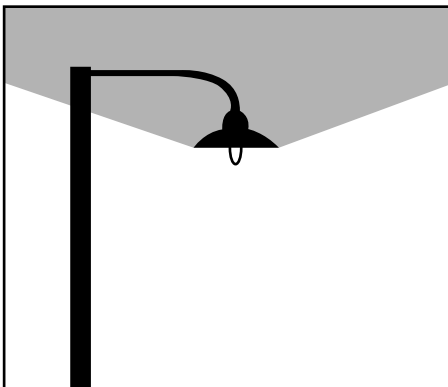

ARM-MOUNTED AREA LIGHTING, DECORATIVE "PENDANT" FIXTURE

MOUNTING SUITABILITY:

Poor to very poor, depending upon mounting height. Should not be mounted higher than 5 m within 150 m of a nesting beach.

DIRECTIONAL SUITABILITY:

Poor. Difficult to shield properly.

OVERALL SUITABILITY:

Poor.

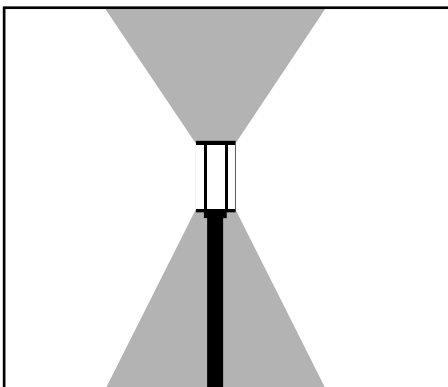

DECORATIVE "CARRIAGE" LIGHTING

MOUNTING SUITABILITY:

Fair if mounted at heights lower than 2 m. Poor if mounted higher.

DIRECTIONAL SUITABILITY:

Very poor. Fair if properly shielded.

OVERALL SUITABILITY:

Poor.

**ARM-MOUNTED CUTOFF LIGHTING,
"SHOEBOX" FIXTURE**

MOUNTING SUITABILITY:

Good to poor, depending on mounting height. Mounting height should be no more than 5 m within 100 m of a nesting beach.

DIRECTIONAL SUITABILITY:

Fair to good, as determined by reflectors.

OVERALL SUITABILITY:

Fair to good when mounting heights are low and fixtures are aimed directly downward.

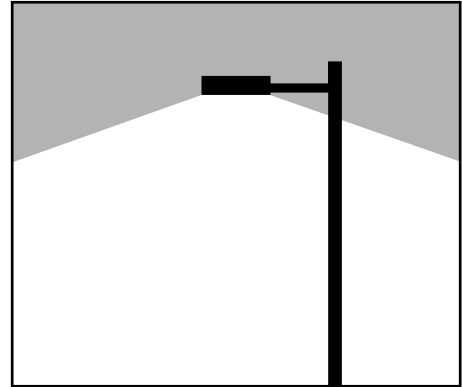

**ARM-MOUNTED AREA LIGHTING,
"COBRAHEAD" FIXTURE**

MOUNTING SUITABILITY:

Poor to very poor, depending on mounting height. Mounting height should be no more than 5 m within 150 m of a nesting beach.

DIRECTIONAL SUITABILITY:

Poor. Difficult to shield properly.

OVERALL SUITABILITY:

Poor.

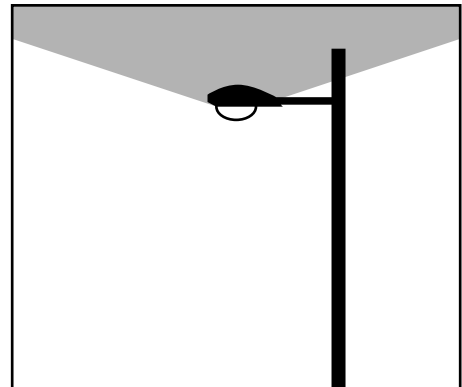

**ARM-MOUNTED AREA LIGHTING,
"FLAT-FACE" CUTOFF FIXTURE**

MOUNTING SUITABILITY:

Good to poor, depending on pole height. Mounting height should be no more than 5 m within 100 m of a nesting beach.

DIRECTIONAL SUITABILITY:

Fair to good, as determined by reflectors.

OVERALL SUITABILITY:

Fair to good when mounting heights are low.

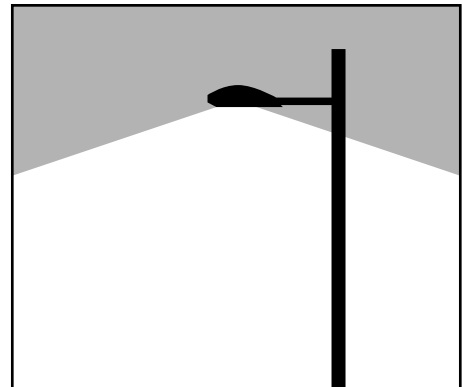

SIGN LIGHTING, BOTTOM-UP STYLE

MOUNTING SUITABILITY:

Poor, because of its potential for producing uplight scatter.

DIRECTIONAL SUITABILITY:

Poor to good.

OVERALL SUITABILITY:

Poor. Signs near nesting beaches should be lighted from the top down. In no case should lighted signs be visible from the beach.

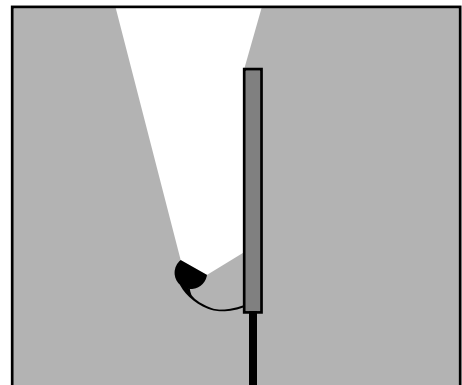

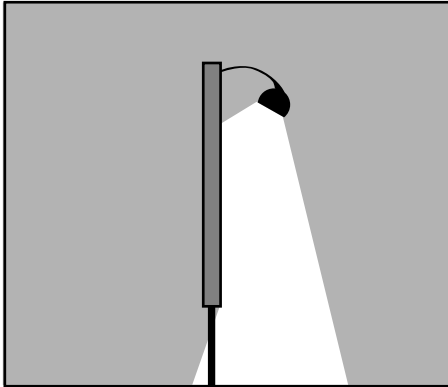

SIGN LIGHTING, TOP-DOWN STYLE

MOUNTING SUITABILITY:

Good.

DIRECTIONAL SUITABILITY:

Poor to good.

OVERALL SUITABILITY:

Generally good if the sign is not visible from the beach and if the lighting is well aimed.

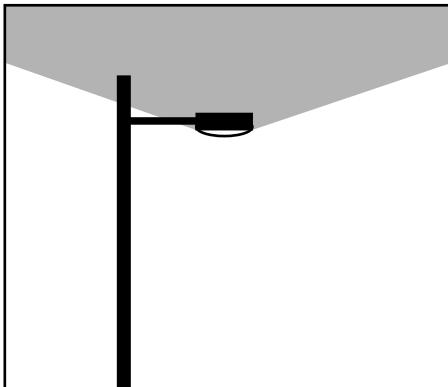

ARM-MOUNTED AREA LIGHTING, FIXTURES WITH REFRACTING GLOBES OR CONVEX LENSES

MOUNTING SUITABILITY:

Poor to very poor, depending upon mounting height. Mounting height should be no more than 5 m within 150 m of a nesting beach.

DIRECTIONAL SUITABILITY:

Poor. Fair to good if shielded properly.

OVERALL SUITABILITY:

Poor.

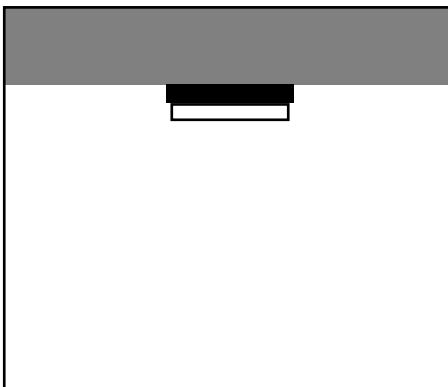

CEILING-MOUNTED AREA LIGHTING, FIXTURES WITH REFRACTING GLOBES OR CONVEX LENSES

MOUNTING SUITABILITY:

Poor if mounted on the beach sides of buildings or on upper stories. Good if shielded from the beach by buildings.

DIRECTIONAL SUITABILITY:

Poor.

OVERALL SUITABILITY:

Poor to fair, depending upon mounting location.

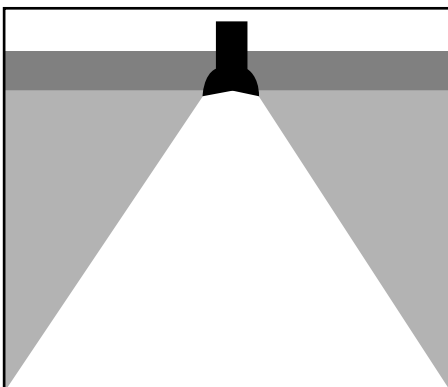

CEILING-RECESSED DOWNLIGHTING WITH BAFFLES TO ELIMINATE LATERAL LIGHT

MOUNTING SUITABILITY:

Good to excellent when mounted in lower-story ceilings and soffits.

DIRECTIONAL SUITABILITY:

Excellent.

OVERALL SUITABILITY:

Good to excellent.

**WALL-MOUNTED AREA LIGHTING,
“JELLY-JAR” PORCH LIGHT FIXTURE**

MOUNTING SUITABILITY:

Poor. Very poor when mounted on upper stories.

DIRECTIONAL SUITABILITY:

Poor.

OVERALL SUITABILITY:

Poor.

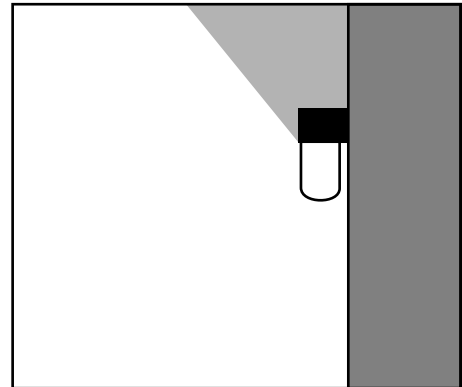

LINEAR TUBE LIGHTING

MOUNTING SUITABILITY:

Excellent if mounted at foot level.

DIRECTIONAL SUITABILITY:

Fair to poor, but this lighting is of concern only if mounted high or if large numbers of high-wattage (>3 W) lamps are used.

OVERALL SUITABILITY:

Excellent if low-wattage strips are used sparingly in recessed areas.

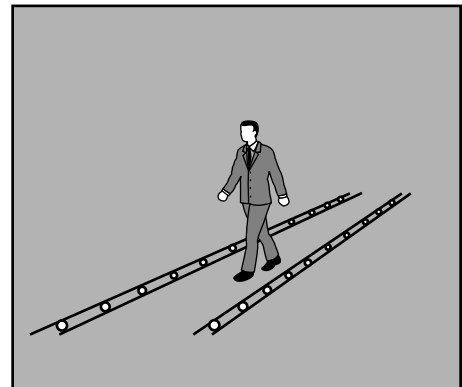

LOUVERED STEP LIGHTING

MOUNTING SUITABILITY:

Excellent if mounted at foot level.

DIRECTIONAL SUITABILITY:

Excellent.

OVERALL SUITABILITY:

Excellent.

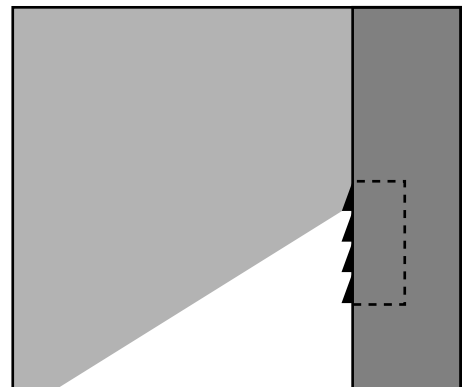

WALL-MOUNTED DOWNLIGHTING

MOUNTING SUITABILITY:

Good to excellent when mounted on lower-story walls.

DIRECTIONAL SUITABILITY:

Excellent.

OVERALL SUITABILITY:

Good to excellent.

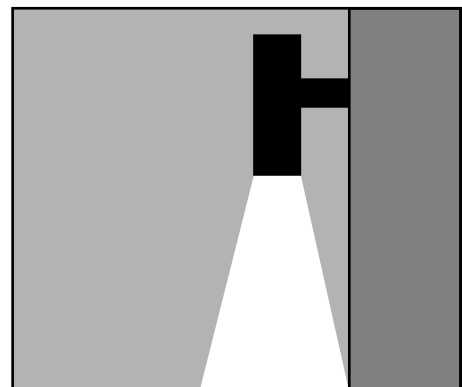

APPENDIX F

Diagrams depicting solutions to two common lighting problems near sea turtle nesting beaches:
balcony or porch lighting and parking-lot lighting.

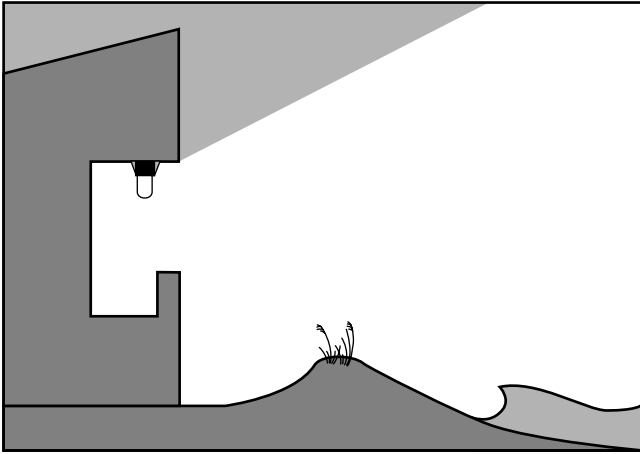

POOR

Poorly directed balcony lighting can cause problems on sea turtle nesting beaches.

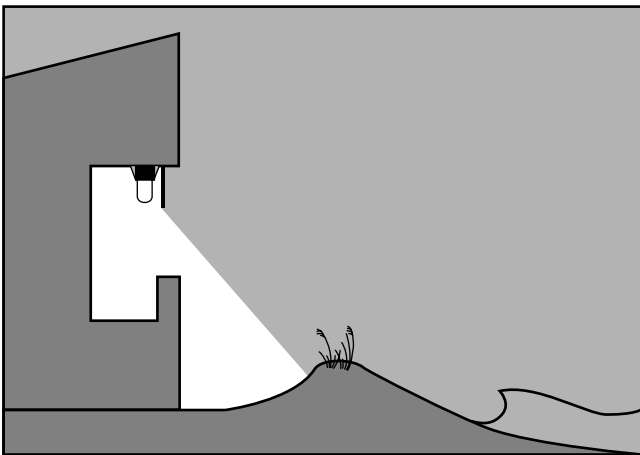

BETTER

Completely shielding fixtures with a sheet of metal flashing can reduce stray light reaching the beach.

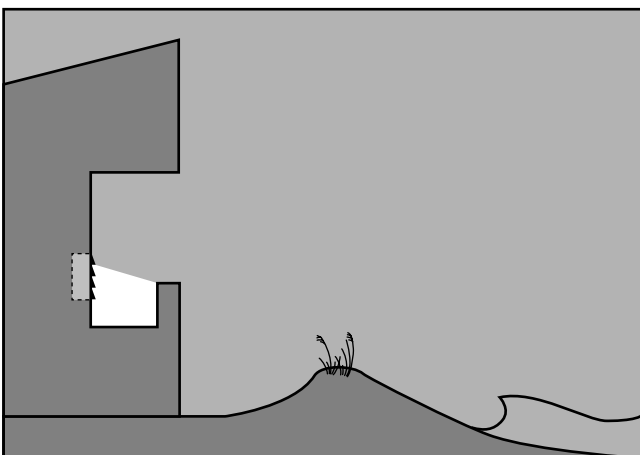

BEST

Louvered step lighting is one of the best ways to light balconies that are visible from nesting beaches.

POOR

Poorly directed parking lot lighting can cause problems on sea turtle nesting beaches.

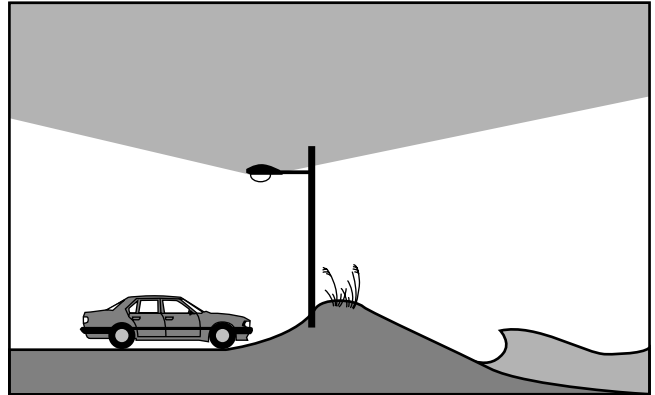

BETTER

Fixtures with 90° cutoff angles can reduce the amount of stray light reaching the beach.

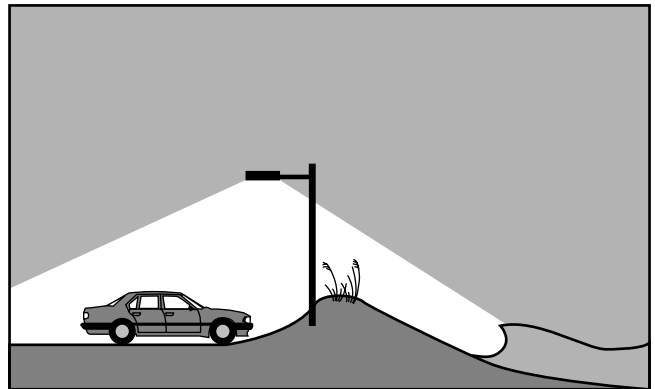

MUCH BETTER

Fully hooded fixtures can direct light accurately and reduce stray light even more.

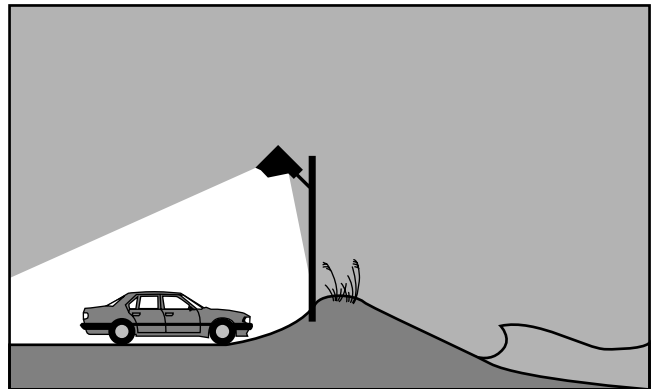

BEST

Low-mounted, louvered bollard fixtures are the best way to light parking lots near nesting beaches.

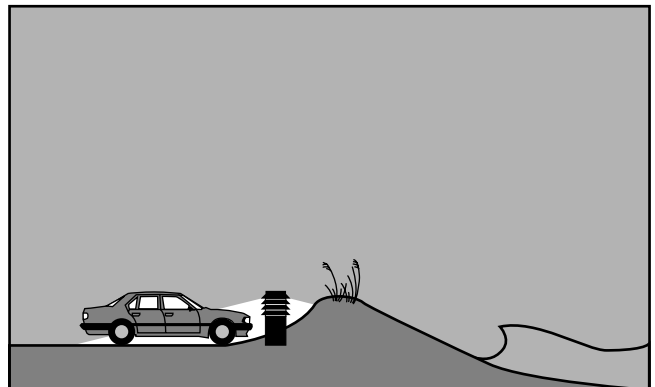

APPENDIX G

The following is a list of the lighting and window-treatment manufacturers and distributors mentioned in this manual.

AFG Industries, Inc.

(tinted glass)

P.O. Box 929
Kingsport, Tennessee 37662 USA
PHONE: 615-229-7200

C-Ran Corporation

(solar lighting)

699 4th Street
Largo, Florida 34640-2439 USA
PHONE: 813-585-3850
FAX: 813-586-1777

ERS

(lamps, fixtures)

5106 Bird Lane
Winter Haven, Florida 33884 USA
PHONE: 813-324-7291

General Electric

(lamps)

GE Lighting
Nela Park
Cleveland, Ohio 44112 USA
PHONE: 216-266-2653
FAX: 216-266-2780

Heath-Zenith

(lamps, fixtures)

455 Riverview Drive
Benton Harbor, Michigan 49022 USA

Hubbell Lighting, Inc.

(lamps, fixtures, shields)

2000 Electric Way
Christiansburg, Virginia 24073-2500 USA
PHONE: 703-382-6111
FAX: 703-382-1526

Hydrel

(lamps, fixtures)

12881 Bradley Avenue
Sylmar, California 91342 USA
PHONE: 818-362-9465
FAX: 818-362-6548

Intermatic, Inc.

(lamps, fixtures)

Intermatic Plaza
Spring Grove, Illinois 60081-9698 USA
PHONE: 815-675-2321 or 312-282-7300

Janmar Lighting

(lamps, fixtures)

892 West 10th Street
Azusa, California 91702-1935 USA
PHONE: 818-969-4111

Lithonia Lighting

(lamps, fixtures)

P.O. Box A
Conyers, Georgia 30207 USA
PHONE: 404-922-9000
FAX: 404-483-2635

Luminaire Technologies, Inc.

(lighting shields)

212 West Main Street
Gibsonville, North Carolina 27249 USA
PHONE: 910-449-6310

Osram Sylvania Incorporated

(lamps)

National Consumer Support Center
18725 North Union Street
Westfield, Indiana 46074 USA
PHONE: 508-777-1900 or 800-842-7010
FAX: 800-842-7011

Phifer Sunscreen

(window light shades)

P.O. Box 1700
Tuscaloosa, Alabama 35403 USA
PHONE: 205-345-2120 or 800-633-5955

PPG Industries

(tinted glass)

Flat Glass Technical Services
One PPG Place, 31N
Pittsburgh, Pennsylvania 15272 USA
PHONE: 412-434-2858
FAX: 412-434-3675

SOL, Solar Outdoor Lighting, Inc.

(solar lighting)

3131 SE Waaler Street
Stuart, Florida 34997 USA
PHONE: 407-286-9461
FAX: 407-286-9616

Southwall Technologies

(tinted glass)

1029 Corporation Way
Palo Alto, California 94303 USA
PHONE: 415-962-9111

Spaulding Lighting

(lamps, fixtures)

1736 Dreman Avenue
Cincinnati, Ohio 45223 USA
PHONE: 513-541-3486
FAX: 513-541-1454

Specified Lighting, Inc.

(lamps, fixtures)

1322 Southeast 35th Terrace
Cape Coral, Florida 33904 USA

Starfire Lighting

(lamps, fixtures)

317 Saint Pauls Avenue
Jersey City, New Jersey 07306-5021 USA
PHONE: 201-656-7888 or 800-443-8823
FAX: 201-656-0666

Sterner Lighting Systems Incorporated

(lamps, fixtures)

351 Lewis Avenue
Winsted, Minnesota 55395 USA
PHONE: 612-473-1251 or 800-328-7480
FAX: 612-485-2899 or 800-328-3635

Thomas Industries, Benjamin Division

(lamps, fixtures)

P.O. Box 180, Route 70 South
Sparta, Tennessee 38583 USA

Thomas Industries, Gardco Lighting

(lamps, fixtures)

2661 Alvarado Street
San Leandro, California 94577 USA
PHONE: 415-357-6900 or 800-227-0758

Quality Lighting

(lamps, fixtures)

P.O. Box 309
Franklin Park, Illinois 60131-0309 USA
PHONE: 708-451-0040
FAX: 708-451-6768

Voigt Lighting

(lamps, fixtures)

135 Fort Lee Road
Leonia, New Jersey 07605 USA
PHONE: 201-461-2493
FAX: 201-461-7827

APPENDIX H

CHAPTER 62B-55 Model Lighting Ordinance for Marine Turtle Protection

62B-55.001 Purpose and Intent.

62B-55.002 Definitions.

62B-55.003 Marine Turtle Nesting Areas.

62B-55.004 General Guidance to Local Governments.

62B-55.005 Prohibition of Activities Disruptive to Marine Turtles

62B-55.006 Model Standards for New Lighting.

62B-55.007 Model Standards for Existing Lighting.

62B-55.008 Proposed Enforcement and Penalties.

62B-55.009 Monitoring and Reporting Guidance.

62B-55.001 Purpose and Intent.—The purpose of this rule is to implement Section 161.163, Florida Statutes, which requires the department to designate coastal areas utilized, or likely to be utilized, by sea turtles for nesting, and to establish guidelines for local government regulations that control beachfront lighting to protect hatching sea turtles. This rule is intended to guide local governments in developing ordinances which will protect hatchling marine turtles from the adverse effects of artificial lighting, provide overall improvement in nesting habitat degraded by light pollution, and increase successful nesting activity and production of hatchlings.

Specific Authority 161.163 F.S., Law Implemented 161.163 F.S., History—New 3-93.

62B-55.002 Definitions.

(1) “Artificial light” or “artificial lighting” means the light emanating from any human-made device.

(2) “Beach” means the zone of unconsolidated material that extends landward from the mean low water line to the place where there is a marked change in material or physiographic form, or to the line of permanent vegetation, usually the effective limit of storm waves.

(3) “Bug” type bulb means any yellow colored light bulb that is marketed as being specifically treated in such a way so as to reduce the attraction of bugs to the light.

(4) “Coastal construction activities” means any work or activity that is likely to have a material physical effect on existing coastal conditions or natural shore and inlet processes.

(5) “County” means Bay, Brevard, Broward, Charlotte, Citrus, Collier, Dade, Dixie, Duval, Escambia, Flagler, Franklin, Gulf, Hernando, Indian River, Jefferson, Lee, Levy, Manatee, Martin, Monroe, Nassau, Okaloosa, Palm Beach, Pasco, Pinellas, St. Johns, St. Lucie, Santa Rosa, Sarasota, Suwanee, Taylor, Volusia, Wakulla, and Walton Counties.

(6) “Cumulatively illuminated” means illuminated by numerous artificial light sources that as a group illuminate any portion of the beach.

(7) “Department” means the Florida Department of Natural Resources.

(8) “Directly illuminated” means illuminated as a result of glowing element(s), lamp(s), globe(s), or reflector(s) of an artificial light source which is visible to an observer on the beach.

(9) “Dune” means a mound or ridge of loose sediments, usually sand-sized, lying landward of the beach and deposited by any natural or artificial mechanism.

(10) “Frontal dune” means the first natural or man-made mound or bluff of sand which is located landward of the beach and which has sufficient vegetation, height, continuity, and configuration to offer protective value.

(11) “Ground-level barrier” means any vegetation, natural feature or artificial structure rising from the ground which prevents beachfront lighting from shining directly onto the beach-dune system.

(12) “Hatchling” means any species of marine turtle, within or outside of a nest, that has recently hatched from an egg.

(13) “Indirectly illuminated” means illuminated as a result of the glowing element(s), lamp(s), globe(s), or reflector(s) of an artificial light source which is not visible to an observer on the beach.

(14) "Local government" means any county listed in (4) above and any municipality, community development district, or special taxing district within those counties.

(15) "Marine turtle" means any marine-dwelling reptile of the families Cheloniidae or Dermochelyidae found in Florida waters or using the beach as nesting habitat, including the species: *Caretta caretta* (loggerhead), *Chelonia mydas* (green), *Dermochelys coriacea* (leatherback), *Eretmochelys imbricata* (hawksbill), and *Lepidochelys kempi* (Kemp's ridley). For purposes of this rule, marine turtle is synonymous with sea turtle.

(16) "Nest" means an area where marine turtle eggs have been naturally deposited or subsequently relocated.

(17) "Nesting season" means the period from May 1 through October 31 of each year for all counties except Brevard, Indian River, St. Lucie, Martin, Palm Beach, and Broward. Nesting season for Brevard, Indian River, St. Lucie, Martin, Palm Beach, and Broward counties means the period from March 1 through October 31 of each year.

(18) "Nighttime" means the locally effective time period between sunset and sunrise.

(19) "Person" means individuals, firms, associations, joint ventures, partnerships, estates, trusts, syndicates, fiduciaries, corporations, and all other groups or combinations.

(20) "Tinted glass" means any glass treated to achieve an industry-approved, inside-to-outside light transmittance value of 45% or less. Such transmittance is limited to the visible spectrum (400 to 700 nanometers) and is measured as the percentage of light that is transmitted through the glass.

62B-55.003 Marine Turtle Nesting Areas.—Scientific investigations have demonstrated that marine turtles can nest along the entire coastline of the state. Historical data are not sufficient to exclude any county as an area utilized by marine turtles for nesting. For the purposes of this rule, however, the coastal areas of the state utilized, or likely to be utilized, by marine turtles for nesting include all beaches adjoining the waters of the Atlantic Ocean, the Gulf of Mexico, and the Straits of Florida and located within Bay, Brevard, Broward, Charlotte, Collier, Dade, Duval, Escambia, Flagler, Franklin, Gulf, Indian River, Lee, Manatee, Martin, Monroe, Nassau, Okaloosa, Palm Beach, Pinellas, St. Johns, St. Lucie, Santa Rosa, Sarasota, Volusia, and Walton Counties; and all inlet shorelines of those beaches.

62B-55.004 General Guidance to Local Governments.

(1) The responsibility for protecting nesting female and hatchling marine turtles should be a joint responsibility of local government and the department. Local governments are encouraged to adopt, implement, and enforce the guidelines provided herein to assist in that responsibility. Local governments that have adopted less stringent regulations should consider amending existing ordinances to provide greater protection to nesting marine turtles and hatchlings. In the process of implementing these guidelines, the following management goals should also be considered by local governments:

(a) Public Awareness. Any person submitting an application for coastal construction activities within the jurisdictional boundaries of the local government should be informed of the existence of and requirements within the local government's ordinances concerning artificial lighting and marine turtle protection.

(b) Local Government–Department Communication. Upon adoption of these guidelines, a system of communication between the local government and the department should be developed if it does not already exist. Protection of marine turtle nesting habitat, nesting females, and hatchlings is greatly enhanced when local governments manage their beaches and coastal activities in a manner consistent with prudent marine turtle conservation strategies. The department is ready to assist local governments by providing such conservation information and other technical assistance.

(c) Inter-Governmental Cooperation. Upon adoption of these guidelines, local governments should develop a system for receiving copies of permits issued by the department, the Department of Environmental Regulation, or the United States Army Corps of Engineers for any coastal construction within the local government's jurisdiction. Activities permitted by these agencies should be assessed for compliance with the local government's lighting ordinance.

(d) Enforcement. Local governments should develop a process for the consistent and effective

enforcement of adopted guidelines. This process should include at least one compliance inspection of the beach conducted at night prior to the commencement of the main portion of the marine turtle nesting season and one compliance inspection conducted during the marine turtle nesting season.

(2) The department considers the provisions of this Chapter to be minimum guidelines for the protection of nesting habitat, nesting females, and hatchling marine turtles from the negative effects of artificial lighting. More stringent standards for marine turtle protection may be adopted by local governments. Prior to adoption of any additional standards, local governments are encouraged to consult with the department to ensure that the proposed standards are consistent with the guidelines set forth herein and with all other applicable department rules.

62B-55.005 Prohibition of Activities Disruptive to Marine Turtles.

The following activities involving direct illumination of portions of the beach should be prohibited on the beach at nighttime during the nesting season for the protection of nesting females, nests, and hatchling marine turtles:

- (1) The operation of all motorized vehicles, except emergency and law enforcement vehicles or those permitted on the beach for marine turtle conservation or research.
- (2) The building of campfires or bonfires.

62B-55.006 Model Standards for New Beachfront Lighting.

In order to provide the highest level of protection for nesting marine turtles and their hatchlings, local governments should adopt all of the following standards for artificial light sources on all new coastal construction:

- (1) Exterior artificial light fixtures shall be designed and positioned so that:
 - (a) The point source of light or any reflective surface of the light fixture is not directly visible from the beach;
 - (b) Areas seaward of the frontal dune are not directly or indirectly illuminated; and
 - (c) Areas seaward of the frontal dune are not cumulatively illuminated.
- (2) Exterior artificial light fixtures within direct line-of-sight of the beach are considered appropriately designed if:
 - (a) Completely shielded downlight only fixtures or recessed fixtures having low wattage (*i.e.*, 50 watts or less) "bug" type bulbs and non-reflective interior surfaces are used. Other fixtures that have appropriate shields, louvers, or cutoff features may also be used if they are in compliance with subsection (1)(a), (b), and (c) above; and
 - (b) All fixtures are mounted as low in elevation as possible through use of low-mounted wall fixtures, low bollards, and ground-level fixtures.
- (3) Floodlights, uplights or spotlights for decorative and accent purposes that are directly visible from the beach, or which indirectly or cumulatively illuminate the beach, shall not be used.
- (4) Exterior lights used expressly for safety or security purposes shall be limited to the minimum number and configuration required to achieve their functional role(s). The use of motion detector switches that keep lights off except when approached and that switch lights on for the minimum duration possible are preferred.
- (5) Only low intensity lighting shall be used in parking areas within line-of-sight of the beach. Such lighting shall be:
 - (a) Set on a base which raises the source of light no higher than 48 inches off the ground; and
 - (b) Positioned or shielded so that the light is cast downward and the source of light or any reflective surface of the light fixture is not visible from the beach and does not directly or indirectly illuminate the beach.
- (6) Parking areas and roadways, including any paved or unpaved areas upon which motorized vehicles will park or operate, shall be designed and located to prevent vehicular headlights from directly or indirectly illuminating the beach.
- (7) Vehicular lighting, parking area lighting, and roadway lighting shall be shielded from the beach through the use of ground-level barriers. Ground-level barriers must not interfere with marine turtle nesting or hatchling emergence, or cause short- or long-term damage to the beach/dune system.

- (8) Tinted glass shall be installed on all windows and glass doors of single or multi-story structures within line-of-sight of the beach.
- (9) Use of appropriately shielded low-pressure sodium-vapor lamps and fixtures shall be preferred for high-intensity lighting applications such as lighting parking areas and roadways, providing security, and similar applications.
- (10) Temporary lighting of construction sites during the marine turtle nesting season shall be restricted to the minimal amount necessary and shall incorporate all of the standards of this section.

62B-55.007 Model Standards For Existing Beachfront Lighting. In order to provide the highest level of protection for nesting marine turtles and their hatchlings, local governments should adopt all of the following standards for existing artificial beachfront lighting sources:

- (1) Existing artificial light fixtures shall be repositioned, modified, or removed so that:
 - (a) The point source of light or any reflective surface of the light fixture is not directly visible from the beach;
 - (b) Areas seaward of the frontal dune are not directly or indirectly illuminated; and
 - (c) Areas seaward of the frontal dune are not cumulatively illuminated.
- (2) The following measures shall be taken to reduce or eliminate the negative effects of existing exterior artificial lighting:
 - (a) Reposition fixtures so that the point source of light or any reflective surface of the light fixture is no longer visible from the beach;
 - (b) Replace fixtures having an exposed light source with fixtures containing recessed light sources or shields;
 - (c) Replace traditional light bulbs with yellow "bug" type bulbs not exceeding 50 watts;
 - (d) Replace non-directional fixtures with directional fixtures that point down and away from the beach;
 - (e) Replace fixtures having transparent or translucent coverings with fixtures having opaque shields covering an arc of at least 180 degrees and extending an appropriate distance below the bottom edge of the fixture on the seaward side so that the light source or any reflective surface of the light fixture is not visible from the beach;
 - (f) Replace pole lamps with low-profile, low-level luminaries so that the light source or any reflective surface of the light fixture is not visible from the beach;
 - (g) Replace incandescent, fluorescent, and high intensity lighting with the lowest wattage low-pressure sodium-vapor lighting possible for the specific application;
 - (h) Plant or improve vegetation buffers between the light source and the beach to screen light from the beach;
 - (i) Construct a ground level barrier to shield light sources from the beach. Ground-level barriers must not interfere with marine turtle nesting or hatchling emergence, or cause short- or long-term damage to the beach/dune system;
 - (j) Permanently remove or permanently disable any fixture which cannot be brought into compliance with the provisions of these standards.
- (3) The following measures shall be taken to reduce or eliminate the negative effects of interior light emanating from doors and windows within line-of-sight of the beach:
 - (a) Apply window tint or film that meets the standards for tinted glass;
 - (b) Rearrange lamps and other moveable fixtures away from windows;
 - (c) Use window treatments (*e.g.*, blinds, curtains) to shield interior lights from the beach; and
 - (d) Turn off unnecessary lights.

62B-55.008 Proposed Enforcement and Penalties.—Enforcement, appeal, and remedy of matters related to this Chapter should be regulated pursuant to procedures established under local ordinances. Penalties for non-compliance should be established and should be sufficient to discourage violations. Enforcement capability should be adequate to respond to possible violations within the timeframe necessary to prevent continued and prolonged impacts to marine turtles and hatchlings.

62B-55.009 Monitoring and Reporting Guidance.

The following information should be compiled on an annual basis and submitted to the department.

- (1) Number of lighting applications reviewed;
- (2) Number of potential violations reported;
- (3) Number of potential violations investigated;
- (4) Disposition of all potential violations including results of enforcement actions and amounts of penalties assessed;
- (5) Results of compliance checks conducted prior to and during the marine turtle nesting season; and
- (6) Status of local lighting ordinances and any amendments to those ordinances.

APPENDIX I

The following is a list of conservation organizations, government agencies, and other groups that may be able to assist in resolving light-pollution problems on sea turtle nesting beaches.

Caribbean Conservation Corporation¹

P.O. Box 2866
Gainesville, Florida 32602 USA
PHONE: 904-375-6441

Center for Marine Conservation¹

1725 DeSales Street, NW
Washington, DC 20036 USA
PHONE: 202-429-5609

Ecological Associates, Inc.¹

P.O. Box 405
Jensen Beach, Florida 34958 USA
PHONE: 407-334-3729

Florida Marine Research Institute^{1,2,4}

Florida Department of Environmental Protection
Tequesta Field Laboratory
19100 SE Federal Highway
Tequesta, Florida 33469 USA
PHONE: 407-575-5407

Florida Marine Research Institute^{1,2,4}

Florida Department of Environmental Protection
Resource Recovery, Marine Turtles
100 Eighth Avenue SE
St. Petersburg, Florida 33701 USA
PHONE: 813-896-8626

Florida Power and Light Company²

Environmental Affairs Department
P.O. Box 088801
North Palm Beach, Florida 33408
PHONE: 407-625-7620 or 800-342-5375
FAX: 407-625-7665

International Dark-Sky Association⁵

3545 North Stewart
Tucson, Arizona 85716 USA

IUCN—The World Conservation Union³

Marine Turtle Specialist Group, Chair
Archie Carr Center for Sea Turtle Research

223 Bartram Hall
University of Florida
Gainesville, Florida 32611 USA

Office of Protected Species Management^{1,2}

Florida Department of Environmental Protection
3900 Commonwealth Blvd., M.S. 245
Tallahassee, Florida 32399 USA
PHONE: 904-922-4330

Ogasawara Marine Center⁴

Byobudani, Chichijima
Ogasawara-mura, Tokyo, JAPAN

Programa de Tortugas Marinas⁴

Escuela de Biología
Universidad de Costa Rica
San Jose, COSTA RICA

PRONATURA—Yucatán⁴

Calle 13, #203A
Col. García Gineres
Mérida, Yucatán, MEXICO

Queensland National Parks and Wildlife Service⁴

Sea Turtle Research
P.O. Box 155, Brisbane Albert Street
Queensland 4002 AUSTRALIA

Sea Turtle Protection Society—Greece⁴

Solomou 35
GR-106 82 Athens, GREECE
PHONE: 30-1-364-4146

TAMAR^{1,4}

CAIXA Postal 2219
Salvador, Bahia
C.E.P. 40210-970, BRASIL

United States Fish and Wildlife Service⁴

National Sea Turtle Coordinator
P.O. Box 1306
Albuquerque, New Mexico 87103 USA

WIDECAST¹

17218 Libertad Drive
San Diego, California 92127 USA
PHONE: 619-451-6894
FAX: 619-451-6894

World Wildlife Fund¹

1250 24th Street NW
Washington, DC 20036 USA

¹May be able to assist in education and legislation efforts.

²Offers a pamphlet for distribution entitled "Sea Turtles and Lights" and a booklet on general sea turtle biology (Van Meter, 1992).

³Maintains worldwide contacts with sea turtle researchers and conservationists.

⁴Compiles national or regional data gathered at sea turtle nesting beaches.

⁵Compiles and distributes information on the causes and effects of light pollution.

APPENDIX J

Responses to some common questions and comments regarding sea turtles and lighting.

When do hatchling sea turtles emerge from their nests?

The first hatchlings of the season emerge from nests approximately eight weeks after the first nesting of the season, and this activity continues for up to eight weeks after the final nesting of the season. Outside the tropics, hatchlings generally emerge throughout the summer and early fall. In the southeastern USA, hatchlings emerge throughout the months of June, July, August, September, and October. It is a myth that hatchlings emerge only around the time of the full moon. Hatchlings ready to emerge wait just beneath the sand surface until conditions become cool. This temperature cue prompts them to emerge primarily at night, although some late-afternoon and early-morning emergences have been documented.

How do hatchling sea turtles know where the ocean is when they emerge from their nests?

Sea turtle hatchlings have an inborn tendency to move in the brightest direction. On a natural beach, the brightest direction is most often the open view of the night sky over, and reflected by, the ocean. Hatchlings also tend to move away from darkly silhouetted objects associated with the dune profile and vegetation. This sea-finding behavior can take place during any phase and position of the moon, which indicates that hatchlings do not depend on lunar light to lead them seaward.

Why do artificial light sources attract hatchling sea turtles?

Hatchlings that crawl toward artificial light sources are following the same instinctive response that leads them seaward on naturally lighted beaches. The apparent brightness and glare of artificial lighting is what often leads hatchlings astray. To a hatchling on a beach, an artificial light source appears bright because it is relatively close by, yet it is not intense enough to brighten the sky and landscape. The resulting glare makes the direction of the artificial source appear overwhelmingly bright—so much brighter than the other directions that hatchlings will ignore other visual cues and move toward the artificial light no matter where it is relative to the sea.

There are other lights near my beachfront property that are visible from the beach. Why should I modify my lights?

Any reduction in the amount of artificial light reaching the nesting beach helps sea turtles. As lighting is reduced, hatchlings emerging on moonlit nights and at locations far from the lighted property will have a better chance of finding the sea.

Can hatchlings be protected by increasing the number of lights on a nesting beach in order to prevent turtles from nesting?

Although artificial lighting tends to deter sea turtles from nesting, many do nest on lighted beaches. Apparently, the level of artificial lighting necessary to misdirect hatchlings is well below the level necessary to deter nesting. But even if beaches were lighted to the extent that no nesting occurred, hatchlings on adjacent beaches would be harmed. Regardless, chasing sea turtles away from nesting beaches means that important habitat is lost to them; therefore, it is not a beneficial conservation strategy.

How bright can a light be without affecting hatchlings or adult sea turtles on the beach?

Unfortunately, no simple measure of light intensity can reveal whether a light source will be a problem. The effects of artificial lighting on sea turtles may actually increase as ambient light-levels decrease on darker, moonless nights. Because any visible light from an artificial source can cause problems, the most reliable “instruments” to use when making judgments about problem lighting may be the eyes of a human observer on the nesting beach. Any light source producing light that is visible from the beach is likely to cause problems for nesting sea turtles and their hatchlings.

What should be done with misdirected hatchlings found on the beach?

Hatchling sea turtles found wandering away from the ocean should be taken to a darkened portion of beach and allowed to walk into the surf on their own. Those that do not crawl vigorously can be placed in the water and allowed to swim away. In all cases, local natural resource or environmental protection agencies should be notified. Consult Appendix I for a list of governmental and non-governmental conservation organizations.

Whom should I notify about a light that is visible from a sea turtle nesting beach?

The owner or resident of the property where the light source is located should be contacted. In most cases, people are simply unaware rather than uncaring. Local government conservation agencies should also be notified. A growing number of coastal communities have adopted ordinances that prohibit lighting on the beach during the nesting season. Code enforcement offices often oversee the enforcement of these ordinances. If there is inadequate regulation of beach lighting in your area or if lighting problems persist, private conservation organizations may be able to help. Consult Appendix I for a list of governmental and non-governmental conservation organizations.

I do not have the ability to turn off a problem light that is located on my property. What can be done?

Luminaires that do not have convenient on-off switches are most often controlled by the utility company. Property owners should contact the entity to whom electricity bills are paid or to whom lighting lease payments are made.

Will lighting on a pier affect sea turtles on the adjacent beach?

Yes. Lighting on piers is very difficult to shield from the beach. Hatchlings on adjacent stretches of beach may crawl for great distances in the direction of the lighted pier. Hatchlings that enter the water near the pier may linger in the glow beneath the lighted structure and fall prey to fish, also attracted to the light, rather than disperse offshore.

Will placing bright lights on platforms offshore guide hatchlings into the water off lighted beaches?

Apart from being an overly expensive and complicated solution, lighting the ocean to draw hatchlings offshore would probably create additional problems. Lighting on the water can interfere with hatchling dispersal and increase mortality from fish predation.

There is not enough sea turtle nesting on this beach to justify beach-darkening efforts. Why is light-management legislation needed?

Beaches where small numbers of turtles nest can be very important. The entire nesting range of a population may be made up of sparsely nested beaches. Hawksbill turtles, for instance, one of the most endangered sea turtles, do not nest in great numbers anywhere. Moreover, any group of nesting turtles may constitute a genetically unique and vulnerable unit. Losing even small populations may mean the permanent loss of diversity. The irony in disregarding lighting problems at sparsely nested beaches is that artificial lighting may have caused the nesting to be so low. Many lighted beaches with little nesting may again attract more nesting turtles once they are darkened.

Crime will increase if the beach is not lighted.

Generally, beaches are not areas where there is a great need for crime prevention. Very little valuable property is stored on beaches and there is seldom much nighttime human activity to require security. Fortunately, areas adjacent to nesting beaches where people reside, work, recreate, and store valuables can be lighted for protection without affecting turtles on the nesting beach. Where this type of light management was legislated in Florida coastal communities, the Florida State Attorney's Office has found no subsequent increase in crime.

Implementing a beach-darkening program will be prohibitively expensive.

Darkening nesting beaches for sea turtles is one of the least expensive ways we can benefit the environment. The simplest solution to the problem—turning off lights visible from the beach during the nesting season—

costs little or nothing and may actually save money in electricity costs. Most of the essential lighting that remains can easily be shielded so that the light performs its intended function without reaching the beach. Proper shields can be fashioned from inexpensive metal flashing and fastened with screws. Replacing fixtures is more expensive but is necessary only when an owner decides that greater lighting efficiency or aesthetics are a concern. Choosing well-designed fixtures and incorporating light-management techniques into the plans for coastal development are the most effective ways to fulfill lighting needs while protecting sea turtles.

There are too many disadvantages to using low-pressure sodium-vapor lighting to protect sea turtles.

As is true for any light source, there are both advantages and disadvantages to using low-pressure sodium-vapor (LPS) lighting. The following is a list of issues specific to LPS.

Expense—The initial costs of LPS are substantially higher than for incandescent and fluorescent sources but are only slightly higher than costs for high-intensity discharge lighting (*e.g.*, HPS). Operating costs, however, are generally much lower for LPS than for any other commercial source.

Color—Because LPS sources are monochromatic, they give poor color rendition. For safety and security applications, however, full-spectrum color is seldom needed. At U.S. Air Force installations near nesting beaches in Florida (areas certain to have rigorous security requirements), most outside security areas are lighted by LPS sources.

Disposal—The lamps within LPS luminaires contain elemental sodium, a substance that can cause fires if not disposed of carefully. However, unlike the mercury-containing high-intensity discharge lamps (*e.g.*, mercury-vapor, high-pressure sodium vapor), the contents of LPS lamps are not toxic.

Availability—Although LPS luminaires are not as readily available in retail stores as other light sources are, a wide variety of LPS fixtures are available from a number of manufacturers (see Appendices D and G).

Sea turtle nests on our beach are moved to darker areas to protect hatchlings from lighting. Are our lights still a problem?

Yes. Although it may seem that moving nests out of harm's way will solve the problem, doing so only partially solves the problem and may create new ones. In moving nests, nothing is done to prevent lighting from deterring nesting turtles and interfering with their orientation on the beach. Moving nests also has its own negative consequences that stem from the limitations of this technique:

1. In nearly every effort to find nests, some are missed. Hatchlings from missed nests will suffer the effects of beach lighting.
2. Moved clutches of eggs often have poorer hatching rates. Moving eggs kills at least some of them, and often many die, depending upon how skillfully the moving is done.
3. Putting eggs in places other than those chosen by the nesting turtle can be detrimental. A specific nest environment is critical, both for the survivorship of eggs and for the determination of the hatchlings' sex ratio.

How can the sacrifice of human safety and security to save a few sea turtles be justified?

Thankfully, no such choice is necessary. The safety and security of humans can be preserved without jeopardizing sea turtles. The goal of any program to reduce sea turtle harassment and mortality caused by lighting is to manage light so that it performs the necessary function without reaching the nesting beach. Still, some may contend that any inconvenience at all is too much and that the concerns of humans should always outweigh those for turtles. People insistent on this generalization should not ignore the large and resolute constituency that values sea turtles. Sea turtles are valuable to people both ecologically and for pure enjoyment. In many ways, the protection of sea turtles is in our own best interests.

What good are sea turtles?

Measuring the true worth of anything is difficult, but it is especially difficult to make this measurement of a common resource. Although some may appreciate sea turtles more than others, sea turtles are of value to all. Short of a thorough discussion on the ecological place of sea turtles, suffice it to say that the world would be a poorer place to live without them. We just don't know how much poorer. With regard to sacrificing the diversity of life, Aldo Leopold wrote in his *Sand County Almanac*:

"The last word in ignorance is the man who says of an animal or plant: 'What good is it?'... If the biota, in the course of aeons, has built something we like but do not understand, then who but a fool would discard seemingly useless parts? To keep every cog and wheel is the first precaution of intelligent tinkering."

APPENDIX K

A glossary of terms.

- Acceptance cone:** A solid angle that describes the apex of a geometrical cone containing the range of directions from which light can be measured by a detector (or an animal).
- Angle of acceptance:** An angle, usually specified as horizontal or vertical, that describes the range of directions from which light can be measured by a detector (or an animal).
- Anthropogenic:** Originating from the actions or devices of humans.
- Artificial lighting:** Light sources that have been produced by humans.
- Beach:** Dynamic coastal areas of sedimentary deposits, usually sand, between the primary dune and the water.
- Bollard lighting:** Lighting fixtures within a waist-level post or bollard. Bollard fixtures are generally designed to illuminate only the immediate area around the bollard.
- Brightest direction:** The direction in which the perception or measurement of brightness is greatest.
- Brightness:** The perception or measure that describes light intensity with respect to a specific spectral sensitivity and angles of acceptance.
- Bug light:** An incandescent lamp that is tinted yellow in order to attenuate its emission of short-wavelength visible light and thus reduce its attractiveness to insects.
- Candela:** The basic, international unit for measuring luminous intensity.
- Clutch:** A group of eggs deposited within a nest.
- Color rendering:** The effect of a light source on the color appearance of an object.
- Color:** The sensation resulting from stimulation of the retina by light of certain wavelengths.
- Cone of acceptance:** *See* Acceptance cone.
- Crawl:** Used as a noun, the tracks and other disturbances left on a beach by a sea turtle that has attempted to nest.
- Cut-off angle:** The angle between a vertical line through a luminaire and the first line of sight at which the glowing elements of the luminaire are no longer visible.
- Diffuser:** Made of translucent material, the part of a luminaire through which light is diffused. One of the elements of a luminaire that appears to glow. Also called a lens or globe.
- Direct lighting:** A luminaire provides direct lighting if any of the glowing elements of the luminaire are visible to an observer on the beach.
- Directional lighting:** A luminaire that can be aimed so that its light reaches only specific areas.
- Disorientation:** Loss of orientation. Being unable to maintain constant directional movement.
- Downlighting:** Generally canister- or cylinder-shaped lighting fixtures that direct light predominately downward and that possess light baffles to reduce lateral light.
- Efficiency:** For a lamp, the ratio of light output (lumens) to electrical power (watts) consumed.
- Electroretinography (ERG):** A method to determine spectral sensitivity in which the relative electrical potential is measured across retinas exposed to light at specific wavelengths and intensities.
- ERG spectrum:** Measured by electroretinography, the spectral sensitivity of an animal.
- False crawl:** An aborted nesting attempt (emergence onto a beach) by a sea turtle.
- Fixture:** The device that holds, protects, and provides the optical system and power connections for a lamp.
- Floodlighting:** High-intensity lighting that can be directed at various angles to illuminate large areas or objects.

- Fluorescent:** An electric-discharge lamp containing argon, neon, mercury, and in some cases krypton, which is coated inside with phosphors that determine color appearance (most commonly, white) when lighted.
- Footcandle:** The English unit for measuring illuminance; the illumination of a surface uniformly one foot from a point source of one candela; one lumen per square foot; equal to 10.76 lux.
- Globe:** A diffuser, usually hemispherical, of a luminaire. One of the elements of a luminaire that appears to glow.
- Hatching success:** The proportion of eggs in a nest that produce living hatchlings.
- Hatchling:** A newly hatched sea turtle.
- High-pressure sodium vapor (HPS) lamp:** An electric discharge lamp containing an amalgam of sodium and mercury, and rarefied xenon, that appears whitish golden or peach-colored when lighted.
- High-intensity discharge (HID) lamp:** Referring to a group of light sources that include high-pressure sodium-vapor, mercury-vapor, and metal-halide lamps.
- Illuminance:** The density of luminous flux on a surface. Luminous flux includes only visible light. Measured in footcandles or lux.
- Incandescent:** A lamp that produces light by means of an electrically heated glowing metal filament and that appears white when lighted. Includes quartz tungsten halogen (or simply tungsten halogen) sources. May be tinted to vary color (*e.g.*, yellow bug lights).
- Indirect lighting:** A luminaire provides indirect lighting if its light is visible to an observer on the beach only after it is reflected by objects near the beach or scattered by mist.
- Irradiance:** The density of radiant flux on a surface. Radiant flux may include light throughout the spectrum.
- Lamp:** The source of light within a luminaire.
- Lens:** See Diffuser.
- Light:** 1) Visible or near-visible radiant energy. 2) A term often used in place of "luminaire" or "light fixture."
- Light color:** See Color.
- Light fixture:** See Fixture.
- Light shield:** Any opaque material fastened to a luminaire that makes the luminaire produce more directional lighting.
- Light meter:** A detector used to measure levels of visible light, typically luminance or illuminance.
- Light pollution:** The introduction of artificially produced detrimental light into the environment. Similar to light trespass: the emission of light into areas where it is unwanted.
- Louver:** A series of light-blocking baffles used to direct light coming from a luminaire.
- Low-pressure sodium vapor (LPS) lamp:** An electric discharge lamp that contains sodium, neon, and argon and that appears amber yellow when lighted.
- Lumen:** A unit of light output or flux, equal to the amount of light flow from one candela through a unit solid angle.
- Luminaire:** A complete unit that artificially produces and distributes light. An artificial light source, including fixture, ballast, mounting, and lamp(s).
- Luminance:** The luminous flux from a surface or light source, per unit area of the surface. Luminous flux includes only visible light.
- Lux:** The metric unit for measuring illuminance; the illumination of a surface uniformly one meter from a point source of one candela; one lumen per square meter; equal to 0.0929 footcandle.
- Mercury-vapor lamp:** An electric-discharge lamp that contains mercury and argon and is sometimes coated with phosphors; appears whitish when lighted.
- Metal-halide:** An electric-discharge lamp that contains mercury, argon, sodium iodide, scandium iodide, and scandium; appears white when lighted.
- Misorientation:** Orientation in the wrong direction. For hatchling sea turtles on the beach, travel in any direction other than the general vicinity of the ocean.

- Monochromatic:** The description of a light source emitting a very narrow set of wavelengths (*i.e.*, a single color).
- Mounting height:** The vertical distance between a luminaire and the surface to be lighted.
- Nest:** The area of disturbed sand on a beach where a sea turtle has buried a clutch of eggs.
- Nesting success:** The proportion of nesting attempts by a sea turtle (emergences onto the beach) that result in eggs being deposited.
- Photometer:** *See* Light meter.
- Photopigments:** The light-absorbing chemicals within the rod and cone cells of the retina.
- Photopollution:** *See* Light pollution.
- Phototropotactic:** Pertaining to phototropotaxis.
- Phototropotaxis:** Directional movement governed by a weighing of sensory excitation from stimuli received by separate light-sensing structures.
- Primary dune:** Coastal areas of elevated sandy deposits closest to the water; generally has well-established vegetation if it has not been artificially cleared.
- Radiance:** The radiant flux from a surface or light source, per unit area of the surface.
- Radiometer:** An instrument for measuring radiant energy (*e.g.*, visible light).
- Recessed:** A term describing a luminaire mounted within a ceiling opening in such a way that the glowing elements of the luminaire are hidden from view.
- Reflector:** An element of a luminaire that directs light from the luminaire by reflection.
- Retina:** The surface within the vertebrate eye that contains the pigmented cells (rods and cones) that are sensitive to light.
- Sea-finding behavior:** The tendency to move in the direction of the ocean.
- Sex ratio:** The proportion of females to males. Sex ratios of sea turtle hatchlings are determined by the environmental conditions (mostly temperature) under which the eggs incubate.
- Shield:** *See* Light shield.
- Skyglow:** The glow of light scattered by mist and clouds over densely lighted areas.
- Spectral light:** Light composed of specific wavelengths.
- Swash zone:** The beach zone where advancing waves wash up the beach and recede.
- Tier lighting:** Small light fixtures with louvers that restrict light to the immediate area around the fixture. These fixtures are generally mounted at ground level.
- Up-lighting:** Lighting fixtures that are directed upward, usually onto objects (flags, monuments, signs, buildings, *etc.*).
- Urban skyglow:** *See* Skyglow.
- Visible spectrum:** The range of wavelengths visible to humans, generally between 380 (violet) and 760 (red) nanometers.
- Wavelength:** The property of a photon of light that determines its energy and color, usually expressed in nanometers (nm, billionths of a meter).
- Xanthophobia:** The tendency to orient away from sources rich in yellow light. A type of orientation seen in loggerhead hatchlings.